

Bevel Gears Made from Brass, Straight-Tooth System, Ratio 1:1 to 4:1

Material: Ms58 (2.0401).

Milled teeth. Shaft angle = 90°.

The bevel gears only run as a pair at the stated ratio and same module.

Ordering Details: e.g.:

1 Pair of Bevel Gears Ratio 1:1 Mod. 0.5 15 teeth = 2 pieces Product No. 350 206 00.

1 Pair of Bevel Gears Ratio 1.5:1 Mod. 0.5 20/30 Teeth = 1 Piece Product No. 350 252 00 and 1 Piece 350 253 00.

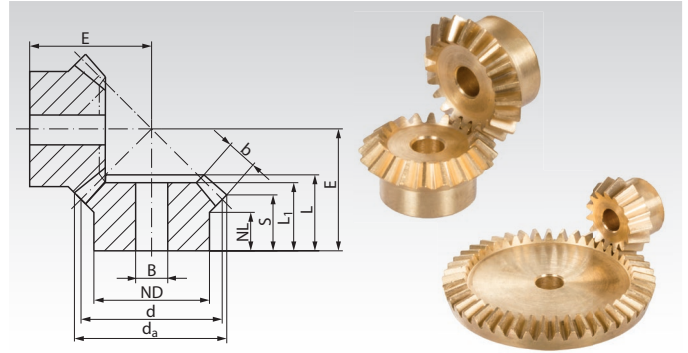

Ratio 1:1

Product No.	Module	Number of teeth	d _a mm	d mm	ND mm	NL mm	L ₁ mm	L mm	S mm	b mm	BH7 mm	E mm	Torque* Ncm	Weight g
350 206 00	0,5	15	8,2	7,5	6	5	6,3	7,3	6,1	2	3	9,5	0,9	1
350 211 00	0,5	20	10,7	10	8	4	-	7	5	3	4	9,7	1,9	1
350 215 00	0,5	24	12,7	12	8	4	6,4	7	5	3	4	10,7	3,0	3
350 220 00	0,5	30	15,7	15	10	4	7,5	8,5	6,6	3	4	13,7	5,3	4
350 223 00	0,5	36	18,7	18	12	5	9	10,1	8	3	4	16,7	8,2	10
350 226 00	0,5	40	20,7	20	12	5	8,5	9,5	7,5	3	4	17,1	10,6	10
350 232 00	0,5	50	25,7	25	14	5	8,5	9,5	7,5	3	4	19,6	18,0	16
350 503 00	1	12	13,0	12	8	5	8,5	9,6	7,7	3	5	13,2	5,0	3
350 507 00	1	16	17,4	16	12	5	9	10,3	7,8	4	5	15,1	6,0	9
350 511 00	1	20	21,4	20	15	5	9	10,4	7,8	4	5	17,1	13,0	15
350 516 00	1	25	26,4	25	16	6,7	11,5	13	9,7	5	5	21,5	26,0	26
350 520 00	1	30	31,4	30	16	7	11,5	13,1	9,7	5	5	24,0	40,0	33
350 523 00	1	36	37,4	36	16	7	11,5	13	9,6	5	5	26,9	62,0	43
350 526 00	1	40	41,4	40	16	8	12,5	14	10,6	5	5	29,9	79,0	53
350 532 00	1	50	51,4	50	16	8	12,5	14	10,6	5	6	34,9	130,0	76
350 535 00	1	60	61,4	60	16	8	12,5	14,1	10,6	5	6	39,9	197,0	110

Ratio 1.5:1

Product No.	Module	Number of teeth	d _a mm	d mm	ND mm	NL mm	L ₁ mm	L mm	S mm	b mm	BH7 mm	E mm	Torque* Ncm	Weight g
350 252 00	0,5	20	11,0	10	8	3,5	6,5	7,1	4,7	3	4	11,9	2,4	2
350 253 00	0,5	30	15,4	15	10	4	6	7	5,4	3	4	10,1	3,6	4
350 552 00	1	20	22,1	20	15	5	10	11,1	7,2	5	5	21,5	18,0	16
350 553 00	1	30	30,8	30	16	5	9	10,9	8,3	5	5	17,7	27,0	28

Ratio 2:1

Product No.	Module	Number of teeth	d _a mm	d mm	ND mm	NL mm	L ₁ mm	L mm	S mm	b mm	BH7 mm	E mm	Torque* Ncm	Weight g
350 260 00	0,5	20	11,2	10	8	4	7	7,5	5,0	3	4	14,65	2,7	2
350 261 00	0,5	40	20,3	20	12	5	7,5	8,4	7,1	3	4	11,83	5,4	8
350 556 00	1	15	17,4	15	12,5	4,5	9	10,1	5,8	5	5	20,2	9,4	9
350 557 00	1	30	30,6	30	16	5	9	10,8	8,8	5	5	15,7	18,8	27
350 560 00	1	20	22,4	20	15	5	10	11,1	6,8	5	5	26,2	20,6	17
350 561 00	1	40	40,6	40	16	8	12	13,8	11,7	5	6	21,1	41,2	50

Ratio 2.5:1

Product No.	Module	Number of teeth	d _a mm	d mm	ND mm	NL mm	L ₁ mm	L mm	S mm	b mm	BH7 mm	E mm	Torque* Ncm	Weight g
350 272 00	0,5	20	11,3	10	8	4	7	7,6	4,9	3	4	17,1	3,0	3
350 273 00	0,5	50	25,2	25	14	5	7	7,8	6,8	3	4	11,5	7,5	12

Ratio 3:1

Product No.	Module	Number of teeth	d _a mm	d mm	ND mm	NL mm	L ₁ mm	L mm	S mm	b mm	BH7 mm	E mm	Torque* Ncm	Weight g
350 276 00	0,5	15	8,8	7,5	6	3,7	6,5	7	4,3	3	3	15,3	1,5	1
350 277 00	0,5	45	22,7	22,5	12	5	7,5	8,4	7,5	3	4	11,0	4,5	11
350 576 00	1	15	17,7	15	13	5	10	11,1	6,5	5	5	28,5	11,0	10
350 577 00	1	45	45,4	45	16	8	12,5	14,7	13,2	5	6	20,2	33,0	68

Ratio 4:1

Product No.	Module	Number of teeth	d _a mm	d mm	ND mm	NL mm	L ₁ mm	L mm	S mm	b mm	BH7 mm	E mm	Torque* Ncm	Weight g
350 592 00	1	15	17,8	15	13	5,5	10	11	6,3	5	5	35,9	12,2	10
350 593 00	1	60	60,3	60	16	8	12,5	14,6	13,6	5	6	20,5	48,8	110

* Basis for calculations see page 274.