

### User Manual

## Electro bullet magnet, series SPxx..., with control unit Sigmatek

- Fe separation system by electromagnetic force -

- ☺ Suited for removal of Fe parts out of powders and granulates
- ☹ Not suited for badly flowing (sticky) products

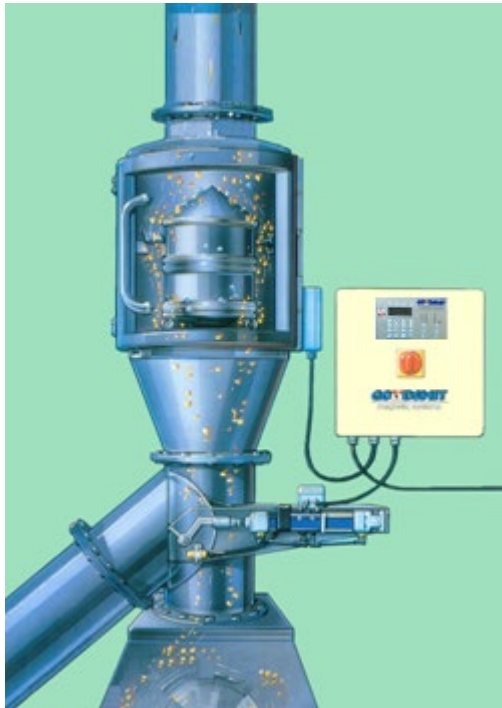

*The descriptions and pictures in this manual, used for explanation, may differ from your execution.  
We have enclosed the as-built drawing of the delivered article.*

---

#### **GOUDSMIT Magnetic Systems B.V.**

P.O. Box 18  
Petunialaan 19  
The Netherlands  
Tel.  
Internet  
E-mail

5580 AA Waalre  
5582 HA Waalre

(+31) (0)40 221.32.83  
[www.goudsmitmagnets.com](http://www.goudsmitmagnets.com)  
[info@goudsmitmagnets.com](mailto:info@goudsmitmagnets.com)



## Versions overview of standard manual

Version	Date	Description
1.0	01-1998	First version of this manual
2.0	09-2004	Complete renewed version
2.1	10-2006	<ol style="list-style-type: none"> <li>1. Remarks regarding overheated magnet core added to pages 11, 18 and 26</li> <li>2. Remarks regarding ATEX added (pages 7, 8, 9, 22 en 27)</li> </ol>
2.2	02-2007	<ol style="list-style-type: none"> <li>1. Revisions page added</li> <li>2. Info regarding terminal strips inside control box added and info regarding electrical connections improved</li> <li>3. Function test added to chapter Startup (page 27)</li> </ol>
2.3	01-2009	<ol style="list-style-type: none"> <li>1. Chapter Trouble shooting changed to Malfunctions/Service</li> <li>2. ATEX remarks and codes adapted to Ex certified body notes</li> </ol>
3.0	09-2009	Article specification sheet and declaration by the manufacturer separated from user manual
3.1	01-2013	HPC controller added
3.2	06-2014	Updated the text regarding the ATEX marking
3.3	07-2019	Sigmathek controller instead of HPC controller

**Introduction**

Read this manual and make sure that you fully understand its contents before commissioning and operating the machine.

If you have any queries or require further explanation regarding any subject related to the machine, please do not hesitate to contact **GOUDSMIT MAGNETIC Systems B.V.**

All technical information contained in this manual, together with any relevant drawings and technical descriptions we supply, remain our property. It may not be duplicated or disclosed without our prior written permission.

The user manual can be ordered together with the device description and/or the article number as well as the order number (ORxxxxxx).

This manual and the declaration by the manufacturer are part of the machine. They must remain with the machine, even if it is sold. The manual must be made available to all operators, service technicians, and others who work with the machine throughout its life cycle.

## List of contents

<b>Versions overview of standard manual .....</b>	<b>2</b>
<b>Introduction.....</b>	<b>3</b>
<b>List of contents .....</b>	<b>4</b>
<b>General.....</b>	<b>5</b>
Ferromagnetism.....	5
Conditions of supply and guarantee .....	6
Delivery .....	7
<i>General .....</i>	<i>7</i>
<i>Identification plate.....</i>	<i>7</i>
<i>Description Goudsmit Ex code dust zones .....</i>	<i>8</i>
<i>ATEX explosive zone measures.....</i>	<i>8</i>
<b>Safety.....</b>	<b>10</b>
General .....	10
Danger of dust explosion .....	10
Danger of magnetic field.....	11
Danger of hot surfaces.....	12
Danger of high voltage .....	12
<b>Device description .....</b>	<b>13</b>
Intended use / user indications .....	13
Deliverable specials .....	14
Working principle .....	15
<i>Overheating protection of magnet coil.....</i>	<i>16</i>
<i>Fe disposal cycle .....</i>	<i>17</i>
<i>ON/OFF switching electro bullet magnet.....</i>	<i>17</i>
Control box.....	18
Construction .....	19
<b>Installation .....</b>	<b>21</b>
General .....	21
Valve box.....	22
<i>Compressed air supply.....</i>	<i>22</i>
Electrical connections general .....	23
<i>Electrical connections &amp; EX.....</i>	<i>23</i>
Gasket material / grounding.....	23
<b>Start-up .....</b>	<b>24</b>
<b>Maintenance .....</b>	<b>25</b>
Cleaning & ATEX .....	26
<b>Malfunctions/Service .....</b>	<b>27</b>
<b>Spare parts.....</b>	<b>28</b>
<b>Storage and Dismantling .....</b>	<b>29</b>

## General

This user manual contains information for the correct operation and maintenance of your device. It also contains instructions for avoiding possible injury and serious damage and it allows a safe and as trouble-free functioning of the product as possible. Read this manual thoroughly before putting the device into operation, familiarise yourself with the operation and control of the device and follow all instructions precisely.

- *The data published in this instruction manual is based on the available information at the time of delivery. This is issued subject to later amendment.*
- *We retain the right to amend or modify the construction and/or model of our products at any time whatsoever without any obligation to modify any previously supplied products accordingly.*

## Ferromagnetism

The working principle of the device rests on (Ferro)magnetism.

Ferromagnetism is the basic mechanism by which certain materials such as iron cobalt and nickel can get magnetized when exposed to an externally applied magnetic field. Materials that remain magnetized after the external magnetic field is removed, are called permanent magnets. Most magnetic materials lose their magnetism after the external magnetic field is removed. Most alloys of iron, cobalt and nickel are magnetic. However, some stainless steel alloys like AISI304 or AISI316 are only slightly magnetic.

Because in most cases it will be Fe parts that will be Ferro-magnetically influenced, we will use the term 'Fe' in this user manual when we mean ferromagnetic material

## Conditions of supply and guarantee

The conditions of supply are the “**General Conditions for the supply and erection of mechanical, electrical and electronic products**” (SE01), published by **Orgalime**, in Brussels.

These conditions can also- if desired – be requested by writing to Goudsmit Magnetic Systems B.V., as also mentioned in our written quotation.

The guarantee prescriptions are mentioned in these conditions

### The guarantee on your equipment will be void if:

- Service and maintenance are not performed in accordance with the instruction manual or by servicemen who are not especially trained to do the work. We strongly recommend that specific magnetic service and maintenance be carried out by Goudsmit personnel);
- Modifications are made to the equipment without our prior written permission;
- non-original parts or non 100% exchangeable parts are used;
- lubrication products other than those prescribed are used;
- the equipment is used injudiciously, incorrectly, negligently or not in accordance with its intent and/or purpose (see chapter “Intended use / user instructions”).



All parts that are subject to wear are excluded from the guarantee

### Remaining remarks / warnings:

- Use the device only for the application for which it has been designed (see chapter “*Intended use / user instructions*”);
- Use the device only when it is in technically perfect condition, and ensure that all protective hoods or inspection covers, including all safety circuits, have been fitted and installed in the correct manner;
- Ensure that device maintenance is appropriate and in accordance with the instructions provided in this user manual;
- Any eventual faults, in particular those that may influence safety, should be attended to immediately and remedied before renewed operation. Should you, after estimating the risks of an unsolved fault, still think it is safe to keep the device into operation, then warn the operators and maintenance staff of these faults and the danger(s) caused by these faults.

**Delivery**

**General**

Check the shipment immediately on delivery for:

- Possible damage and/or shortcomings as a result of transport. If so, ask the transporter to draw up a transport damage report.
- Completeness of the delivery/deliveries, the absence of anything (additionally) ordered.



Always immediately contact **GOUDSMIT magnetic systems** in the event of any damage and/or mistaken delivery.

**Identification plate**

On the device you will find an identification plate as pictured below. **Information on this plate is of great importance in case of service.** That is why we advise to maintain this plate on the device at all times. Ensure that it is always legible by cleaning regularly.

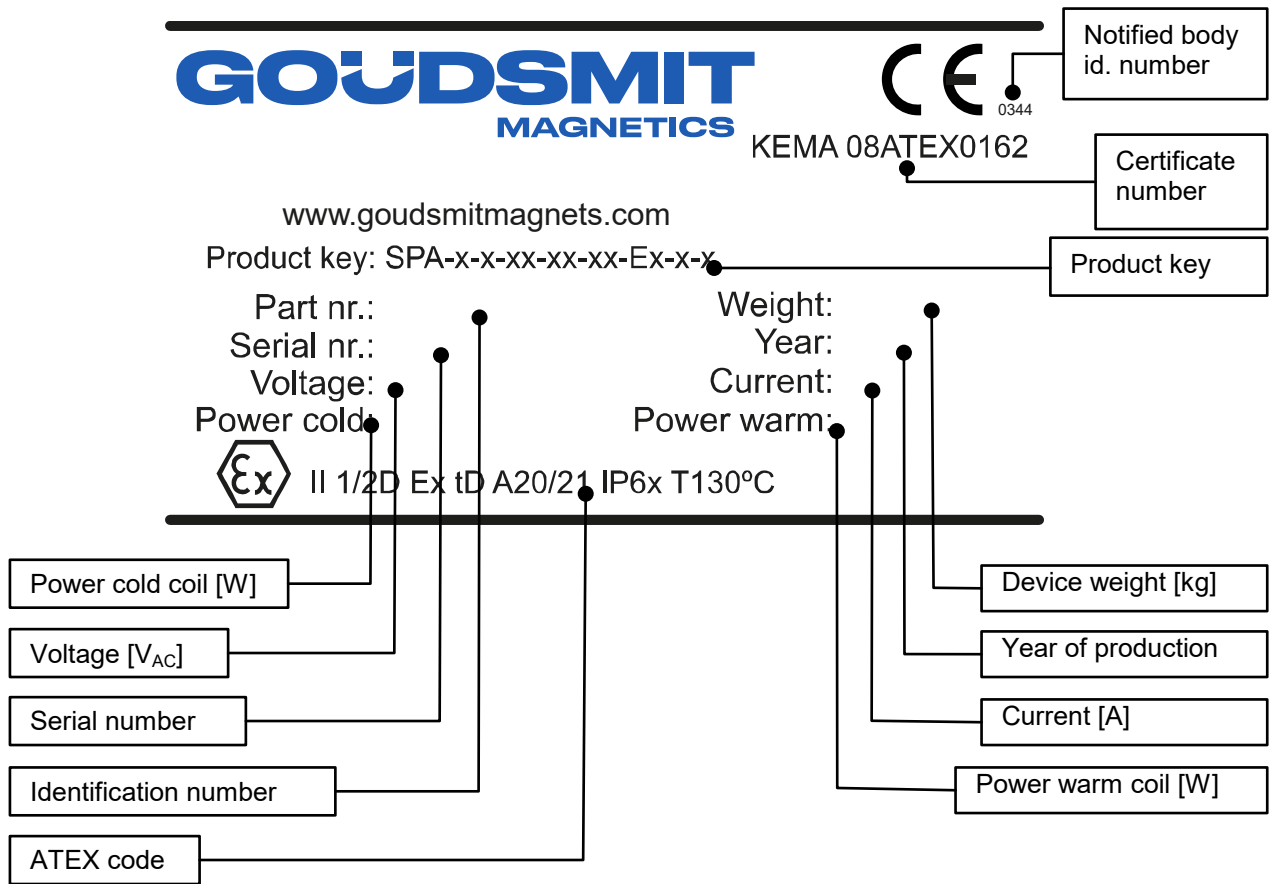

**Don't forget to make note of the Serial Number and the Item number in case of breakdown(s) and or delivery of spare parts.**  
If your identification plate is damaged, contact us and we will send a new one as soon as possible.

## Description Goudsmit Ex code dust zones

When the device is ordered for use in a dust Ex zone, then a dust Ex code is added to the identification plate, which describes the category to which the device complies:

- Code example:  II 1D/2D Ex tD A20/21 IP6x T130°C
- Explanation:
  - II → explosion group (I is underground mining, II is other)
  - 1D/2D → Category (1 = very high, 2 = high, 3 = normal) (D = dust)
    - Zone (20, 21, 22) (allowed to be used in .....
    - 1D inside device / 2D outside device
  - tD → Type of Ex protection used by Goudsmit
  - A20/21 → Safety level; device is suited for these zones in-/outside
  - IP6x → Protection degree
  - T130°C → Maximum surface temperature in relation to dust
  - Ta → Ambient temperature range; only displayed when the range deviates from the standard temperature range for ATEX of -20 ... +40°C

If the device is externally certified, then the ATEX certificate number is added to the type plate. Next to the CE mark the identification number of the Notified Body that certified our ATEX quality assurance system is displayed.

In case the equipment contains no 'own ignition sources' and therefore is not under scope of the ATEX Directive, then the equipment will not get an EX marking and will be supplied with a Statement of Exclusion, in which this is stated and the EX zones are listed in which it can be safely used.

## ATEX explosive zone measures

- If the device has been ordered for use in a potentially explosive area, make sure that no higher surface temperature arises than permitted by ATEX.

*The ATEX marking on the Goudsmit identification plate only applies to the product produced by Goudsmit Magnetic Systems B.V.*

Make sure no particles > 10 mm are present in the product flow.  
These can damage the magnet or extractor bars or cause impact sparks.  
**If necessary install a mechanical filter (sieve) before the separating equipment!**

- The ATEX certified magnetic device requires additional purchase parts to be certified to the ATEX Directive. This includes control units, connection box(es), switch(es), sensor(s) and pneumatic parts, etc. Make sure that these are fitted by qualified personnel!
- If the device is placed in storage or has a longer standstill, make sure the device is emptied and cleaned.



## General

---

- The device must be grounded, if a gasket is used between the device and the larger installation. Attach a metal strip between the housing of the device and the installation, to make sure the device is grounded.
- All screw connections inside the device must be secured against loosening.  
*The ATEX purchase parts are provided with their own ATEX markings.*

**Safety**

**Regularly check that all warning pictograms are still present and legible, and clean if necessary. Make sure that new pictograms are applied at their correct locations if they have been lost or damaged.**

**General**

The device is provided with safeguards where necessary. Make sure every person who comes in contact with the device, wears adequate personal protection (overalls, safety glasses, hearing protectors, helmet, steel-toed safety shoes etc.).

Areas of the device considered dangerous are marked with warning pictograms.

If the device remains easily accessible to persons, then extra safety precautions (e.g. fencing) must be installed. When safeguards are not possible, make sure clear instructions are given to people using the device.

**Danger of dust explosion**

If this device is made according to an EX dust category (1D/2D/3D, acc. to ATEX equipment directive 2014/34/EU) it can accordingly be used in a dust zone (20/21/22, acc. to ATEX workplace Directive 99/92/EC). The Ex category is then described on the identification plate.



*Make sure that the device complies to the correct explosion category.*



**Danger – dust explosion!**  
*(no sticker on device)*



Also check if **the identification plates of mounted parts** show the correct Ex-category for the Ex zone in which the device will be used.

**Danger of magnetic field**

The magnets generate a powerful magnetic field that strongly attracts ferromagnetic (Fe) materials. Always take into account that these materials may suddenly be drawn towards the magnet, very powerfully. This applies to steel workbenches and steel tools, but also to Ferromagnetic materials carried on your person, such as coins in your wallet or your keys. Make use of non-magnetic tools and workbenches fitted with a wooden worktop and preferably a non-Fe frame (for instance stainless steel).

- ! Always be aware that Ferromagnetic parts will be attracted - even personal items - if you are closer than 0.3 meter to a magnet.



**Danger - strong magnetic field!**

- ! People fitted with pacemakers should on no account enter the magnetic field (within a radius of at least 1 meters).



**Prohibited for people with pacemakers!**

- ! Credit cards, chip cards, computer disks/tapes, computer screens, watches, etc. may be damaged or destroyed if they enter the magnetic field (within a radius of at least 0.5 meter).



**Danger for magnetic cards!**

**Danger of hot surfaces**

During operation, the temperature of the housing can increase to dangerous levels and cause burns to the skin. After switching off the device it may take a long time for the magnet and even its housing to cool down!

If the product flows over the electromagnet it may have a relevant cooling effect, so switch off the electro magnet during production stops.



*Surface temperature of the electro magnet may be dangerously high during and after operation. Let the device cool down before maintenance and switch off the device during production stops!*



**Danger- hot surface**

**Danger of high voltage**

When installing and electrically connecting the device, ensure that the work is performed by suitably qualified personnel.



*Always make sure that the electrical power supply has been switched off if work has to be carried out on the device, as some components may be live.*



**Danger - Electric shock risk**

**Always use the main power switch (on the switch box) to switch off the installation in the event of a dangerous situation. Power should never be restored until the dangerous situation has been resolved.**



**Device description****Intended use / user indications****Products**

Suited for Fe separation of granular and pulverise products, for example in milling plants and hammer mills. Fe particles may damage machine equipment and degrade the quality of in the harvest products such as grain, flour etc.

Suited for use in cattle food, plastics, chemical, pharmaceutical, sand, grinding & cement and ceramic industries.

**Fe parts**

Suited for Fe separation of particles of 50 µm and larger.

Heavy Fe parts that have a compact shape, like cube-shaped or ball-shaped parts are often more difficult to be separated then light weight parts or heavy parts with long or flat shape.

**Temperatures**

Suited for outside temperatures of -20 °C to +40 °C.

Suited for product temperatures up to +80 °C.

**Air pressure product channel**

Not suited for overpressure or underpressure inside the product chute. If you have overpressure or underpressure in the product chute, please contact our sales department.

**Free space**

The free space around the electro bullet magnet has to be about 1 meter for cleaning and maintenance work.

**Noise level**

The noise level of the electro bullet magnet is less than 70 dB. Should it become higher, then the device has to be checked on breakdowns/failures immediately.

**Vibrations**

The vibrations caused by the electro bullet magnet, are caused by the moving flap and cylinder of the valve box. These vibrations and the vibrations of the pipeline should be damped by the means with which it is suspended. Make this construction strong enough.

Too severe vibrations might cause caught Fe parts to “break loose”.

**Cleaning**

Regular cleaning is advised to prevent dust and Fe accumulation on and in the device and the problems that can be caused by that, like a lower flow capacity. Clean at least 2 times a day (more often when proven necessary, less when proven possible).

Clean magnets have the best (satisfying) magnetic separation result!!!

See also chapter [Maintenance](#)

**Deliverable specials****Abrasive products**

If you have an abrasive product, we can supply the magnet core and /or inside housing with a protective coating, like for instance a tungsten carbide or PU coating.

**Use in FOOD product flows**

The standard electro bullet magnet can be adapted so that it can be used in most food streams. There is an AISI304 execution, which already has little gaps. Besides that, the product channel (or even complete housing) can be delivered in gap-free SS AISI304 or AISI316, or in combination with other – for instance prescribed or delivered by customer – food improved materials on request. Surface treatments like electrolytic polishing, staining, etc. are naturally possible on request.

**ATEX**

Read this manual thoroughly for all ATEX measures and remarks

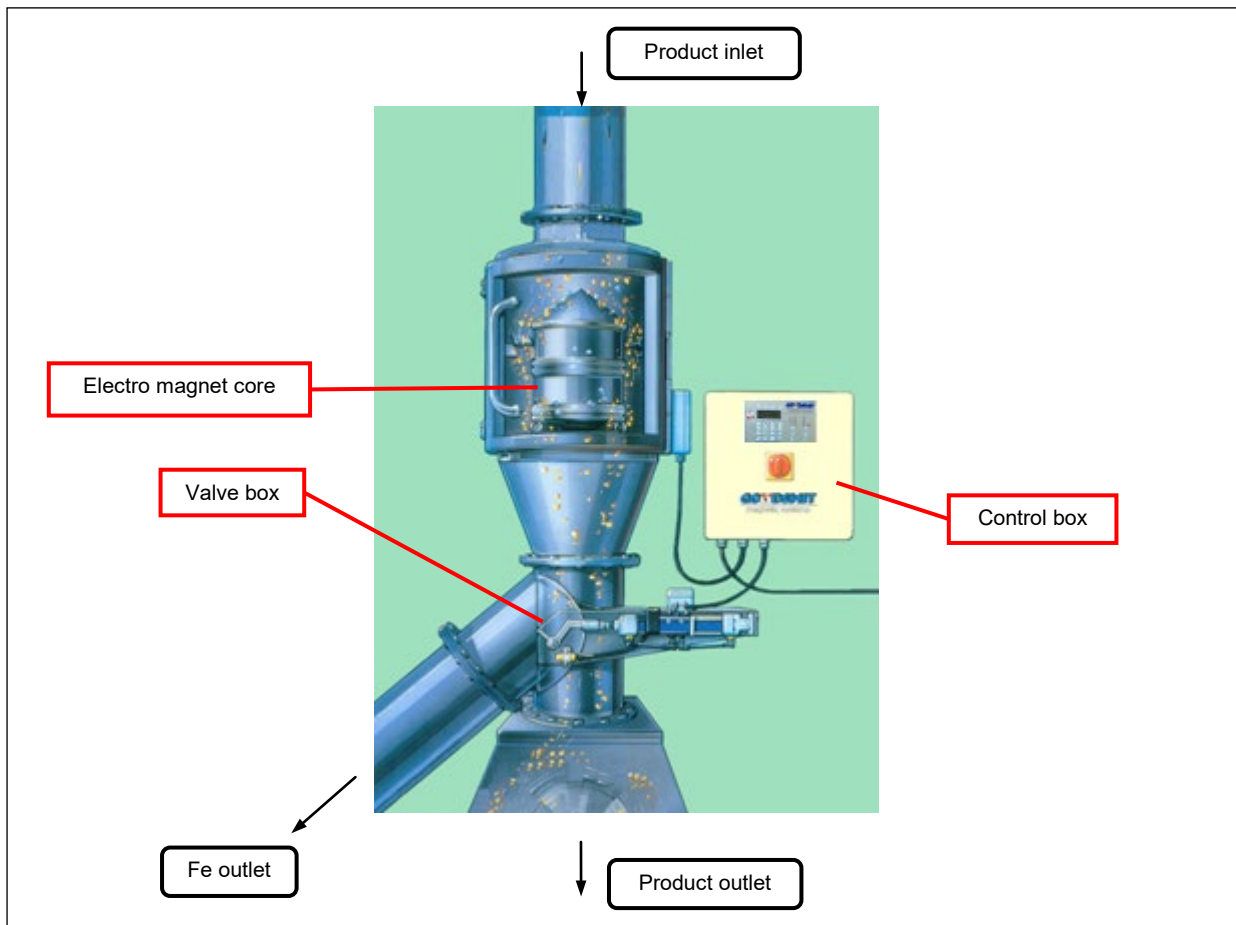
**Working principle**

**Figure:** Working principle electro bullet magnet

- The electro bullet magnet has the function of separating ferromagnetic (Fe) parts out of the passing product flow.
- The 'caught' parts will cling onto the magnet, until the moment that the **electro magnet core** will be "cleaned" of these Fe parts by a **Fe disposal operation**.
- The electromagnetic core is switched off during the cleaning operation to detach all the Fe particles that stick to it.
- If the product flow has been interrupted, the flap of the valve box underneath the magnet has to be (automatically) switched to Fe separation position, to make sure that:
  - Contamination of the product is prevented.
  - The falling Fe parts are guided into the Fe outlet channel.



**During the Fe disposal process the product flow has to be interrupted!**



**Careful: the flap of the valve box can move when magnet is turned ON!**

- The Outlet **valve box** has a **Fe outlet channel** and a **product outlet channel**. The product outlet channel is closed during the cleaning process. The Fe outlet channel is closed during production process.
- If the **valve box** is set in cleaning position, then the electro magnet is switched off and creates a short demagnetising cycle. The Fe parts fall off the magnet and leave via the Fe outlet channel.
- A few seconds later the electro magnet is switched on again, followed by the return of the flap to its production position; the bullet magnet is now ready for production again.

The electro bullet magnet has a universal design, so it can be used in practically all control situations. By using several sorts of sensing, it is possible to integrate the electro bullet magnet in a full-automatic control system, but it is also possible to manually control it on the spot.

**Overheating protection of magnet coil**

FAILURE by overheating will come in as follows:

At  $T_{ALARM}$  the red lamp "Failure" will light up;

At  $T_{TRIP}$  the magnet automatically switches OFF to protect against burning through.

The FAILURE signal can be remote checked via contacts X1-18/19 (Potential free contact).

If the temperature goes above  $T_{TRIP}$  temperature, then following happens:

1. The valve box cylinder moves the flap to its Fe disposal position (safe position for Fe parts to fall into Fe outlet)
2. If the **valve box** is set in cleaning position, then the electro magnet is switched off and creates a short demagnetising cycle. The Fe parts fall off the magnet and leave via the Fe outlet channel.

Power can now only be restored if the magnet has cooled down below  $T_{TRIP}$ .

After this, the electro magnet has to be switched ON again:

1. The magnet will switch ON, directly followed by the flap moving to its production position; yellow lamp goes OUT / green lamp ON.
2. Product flow can now safely be restarted.

**Red lamp / failure specification:**

TYPES	P [W]	E [V]	I [A]	R [ $\Omega$ ]	$T_{ALARM}$ [C] (Red lamp) standard	$T_{TRIP}$ [C] [DOWN] standard	$T_{ALARM}$ [C] (Red lamp) ATEX	$T_{TRIP}$ [C] [DOWN] ATEX
EM1	50	24	2	12	90	115	120	130
EM2	100	24	4.15	5.8	67	80	120	130
EM3	155	24	6.4	3.75	67	80	120	130
EM4	230	42	5.6	7.56	67	80	120	130
EM5	405	44	9.2	4.78	80	90	120	130
EM6	600	44	13.5	3.27	80	90	120	130
EM7	750	44	17	2.58	80	90	120	130
EM8	1400	66	21	3.12	90	100	120	130



Stop the device if the red lamp signal is ON. Refer to the table above for the magnet failure temperature respectively with the magnet specification.



## Fe disposal cycle

1. Stop the product flow.
2. Switch the function switch to position "0" or "Remote".
3. Position "0" – The flap will move directly to its disposal position. Yellow lamp will light up / green lamp will go out.  
Position "Remote" or open PLC contact X1-12/13 – The flap will now move to its disposal position. Yellow lamp will light up / green lamp will go out.
4. When the flap reaches its disposal position (end position switch) the electro magnet will be switched off.
5. The electro magnet (and caught FE parts) will be demagnetised during a few seconds – demagnetising cycle created by the control box. The Fe parts will fall off the magnet core because of this demagnetising cycle.
6. After this the electro magnet can be switched on again.  
Position "Local" – The magnet will switch ON, directly followed by the flap moving to its production position. Yellow lamp goes out / green lamp lights up.  
Position "Remote" or close PLC contact on X1-12/13 – The flap will now move to its disposal position, followed by automatic ON switching of the magnet. Yellow lamp goes out / green lamp lights up.
7. The product flow can now safely be restarted.

## ON/OFF switching electro bullet magnet

The electro bullet magnet has a 100% duty cycle, but only when the product is flowing through, because the passing product has a cooling effect on the electro magnet. The electro bullet magnet thus needs to be switched off while no product is passing the magnet.



**Shut the electro bullet magnet off during production stops!**

**Control box**

This chapter is only applicable if a control box is in the delivery. In all other cases the electro bullet magnet has to be controlled by a self-placed control.

The bullet magnet has a 100% duty cycle, but only if the product is flowing through, because the passing product has a cooling effect on the electro magnet. The electro magnet thus needs to be switched off while no product is passing the bullet magnet.



Prevent the magnet from becoming surrounded by product when in ON position, because it will then become too hot!



**Careful:** the flap of the valve box can move when magnet is turned ON!

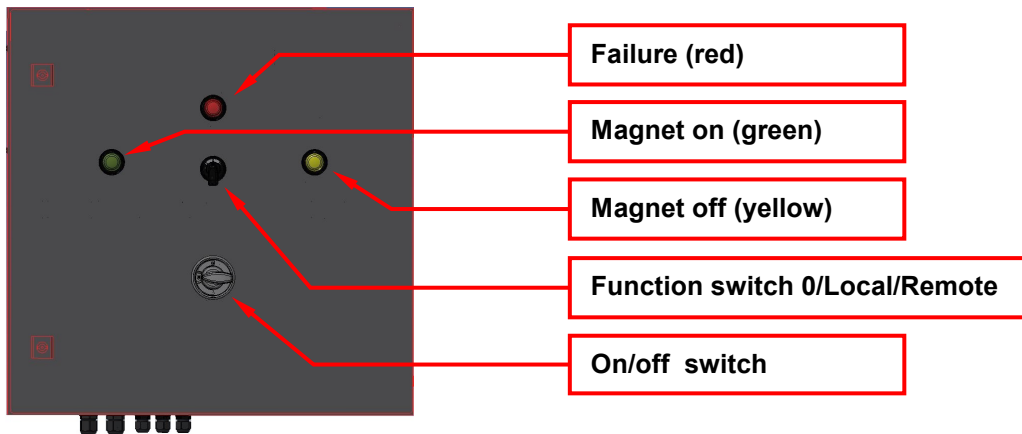

**Figure:** Sigmatek control box

The **FUNCTION SWITCH** - has 3 positions:

- **"0"** makes sure that the flap is in Fe disposal position and that the electro magnet is switched off. The yellow lamp **"MAGNET OFF"** will light up and the magnet will be demagnetised during 2 seconds. Gravity will lead the ferromagnetic parts through the Fe OUT channel. When all Fe parts have passed the Fe OUT channel, the switch can be turned back to production position **"Local"**



**During Fe disposal the product flow must be interrupted!**

- **"Local"** can be used when you want to operate at the magnet. In this position the flap will be set to production position and the magnet will be turned ON. On the control box the green lamp **"MAGNET ON"** will light up, which means that the magnet is ready to separate Fe parts – product flow can be started again.

- "**Remote**" can be used if the magnet will be controlled from a 'remote panel or room'. Via contact X1-12/13 a PLC close contact can set the magnet in production position. The valve box will go in production position and then the magnet will switch on. The green lamp "**MAGNET ON**" will indicate that the magnet is ready to separate Fe parts – product flow can be started. This can be checked remote via contacts X1-14/15 (Potential free contact).

Fe separation in position "**Remote**":

Open the PLC-closed contact on X1-12/13 by remote control.

The red lamp "**FAILURE**" lights up when a failure is detected:

- The door is opened while main power switch is ON (magnet is in production position).
- The electro magnet coil is detected to be overheated ( $T_{ALARM}$ ).

FAILURE by overheating will come in as follows:

- At  $T_{ALARM}$  the red lamp "**FAILURE**" will light up.
- At  $T_{TRIP}$  the magnet automatically switches OFF to protect against burning through.

The green lamp "**MAGNET ON**" lights up when the magnet is ready for production:

- The electro magnet is now ready for use.
- By contacts 16 and 17 on terminal X1 one can let this signal communicate with ones central (24 VAC).

The yellow lamp "**MAGNET OFF**" lights up when the magnet is switched off:

- There should be no product flow now!
- By contacts 14 and 15 on terminal X1 one can let this signal communicate with ones central (24 VAC).

## Construction

- The **electro bullet magnet** has a cylindrical shaped **electro magnet** in an also cylindrical shaped housing. The magnet has 4 steel discs – the **steel poles** – that emit the magnetic fields to which the Fe and other ferromagnetic material will be drawn.
- Cleaning the magnet of caught Fe parts will occur when a cleaning signal is given. The signals will be guided to the electro magnet via **junction boxes** on the magnet housing and on the valve box.
- The **valve** is situated in a **valve box**, which is mounted underneath the magnet housing. The flap is moved by a pneumatic **cylinder**.
- Inside the housing we placed **vanes** to guide the passing product better towards the magnet. This makes the magnet more effective.

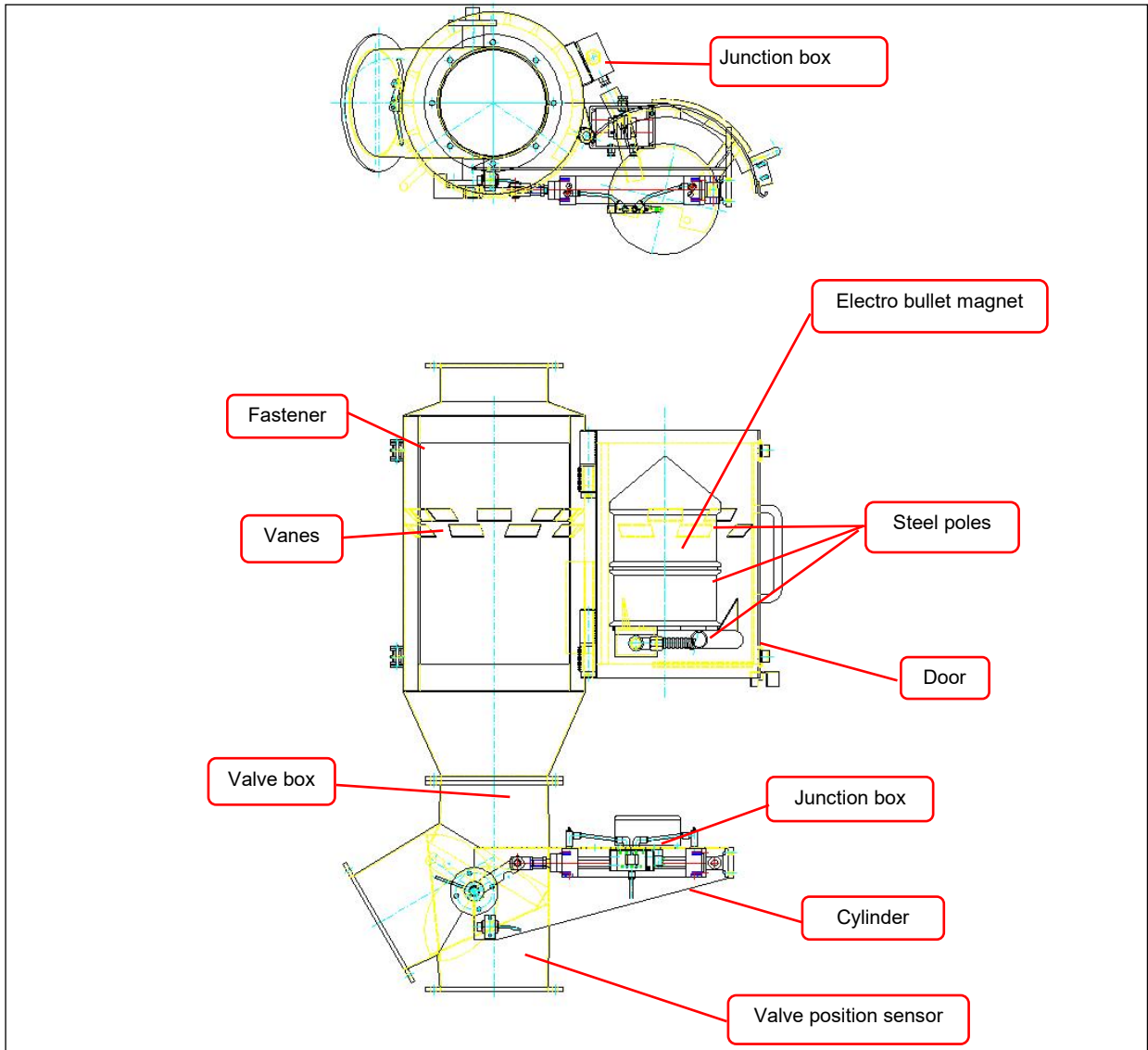

**Drawing:** Construction electro bullet magnet

**Installation****General**

Have all the installation work done by skilled personnel and in accordance with all locally applicable safety regulations.

- Pay attention to the weight of the electro bullet magnet. Your input and output channels must be able to support the bullet magnet.
- If not strong enough, you should stiffen them before you start installing!
- Only make use of lifting/hoisting and transport equipment that is in good condition and never exceed the safe working load of the equipment being used.
- Work safely, ensure sufficient working space and use stable and reliable scaffolding, ladders and other auxiliary equipment to ensure that the machine can be installed without risk.
- All auxiliary equipment used for transport purposes, such as support legs, must be dismantled and removed before putting the machine into operation.
- The device must always be lifted on minimum 2 lifting lugs!
- Close the door properly door to avoid centre gravity shifting during the lifting process. Always use the two eye-bolts in the corner as guidance. Bolt the flanges tidily to prevent leakage during operation. Do not reduce the tension on the lifting chain/belt while positioning, as the electro bullet magnet may fall down to the side.

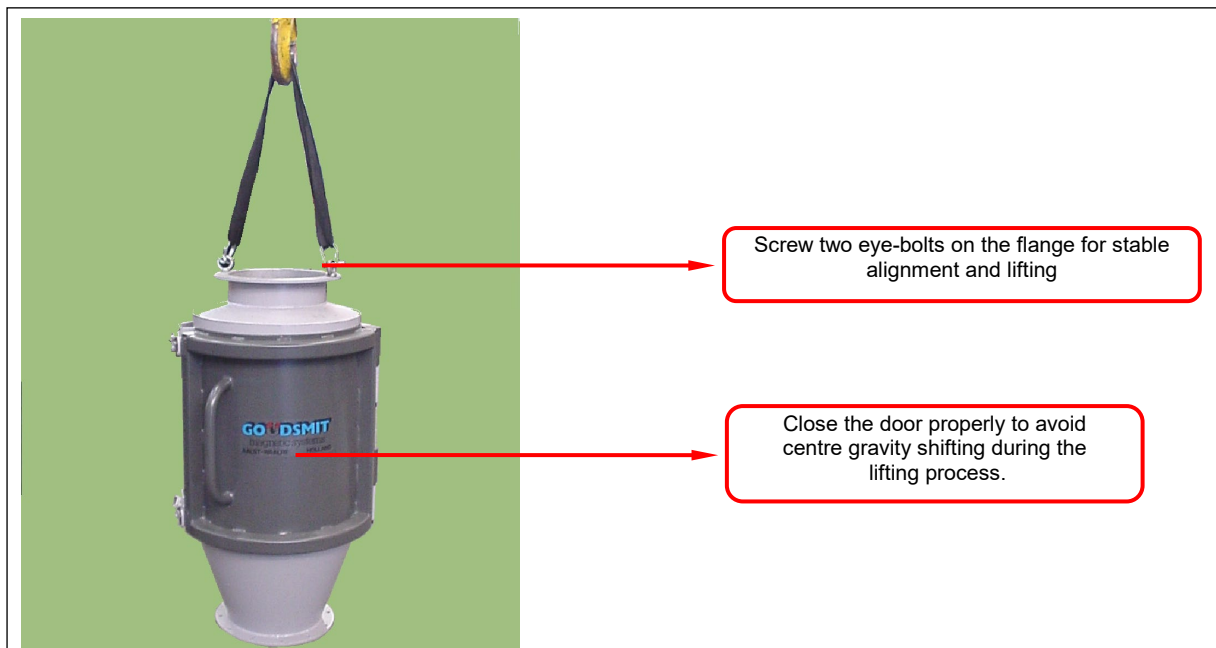

**Photo:** Lifting of the electro bullet magnet

## Valve box

This is the description of the standard execution of the valve box only.

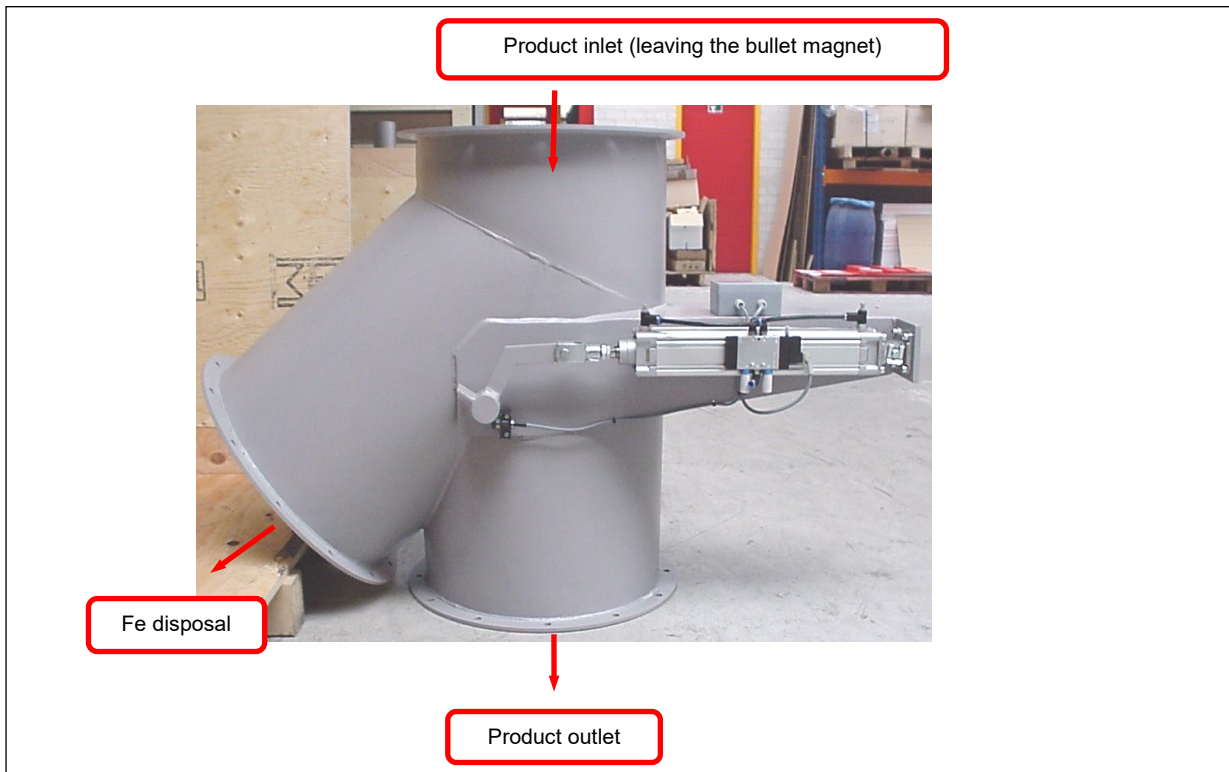

**Photo:** valve box

1. Bolt the flange to the electro bullet magnet housing.
2. Bolt the flanges to the output channels.
3. Screw the two bolts on the corner first to have a good alignment. Bolt the flanges tidily to avoid leakage on the raw products during the Fe Separation process (Four eye bolts can be used for better stability).

## Compressed air supply

Always first connect the compressed air supply, before you apply supply voltage.

The compressed air supply must be between 6 and 10 bar:

$P_{\min} = 4 \text{ bar}$

$P_{\max} = 10 \text{ bar up to } 40^{\circ}\text{C}$

In relation to the compressed air supply is to be paid attention to a sufficiently large cross section of the hose. Moreover a sufficient pressure reserve must be present in the compressed air system. When the air cylinder of the valve box is not supplied by sufficient compressed air, or pressure is too low, a sufficiently fast response time can no longer be ensured and even a standing of the flap can be the consequence.

**Electrical connections general**

Make sure that the electrical power supply is switched off while you work on the device.

Make sure that all electrical connections are made by qualified personnel and conform to all the applicable standards. Check that the device is suitable for connection.



Check all connections regularly!

**Electrical connections & EX**

If the device is placed in an Ex zone, everything you add or change to the device's electrical installation must be executed and documented according to the regulations for the specific Ex zone.

**Gasket material / grounding**

To prevent the build-up of static electricity, make sure there is metal bridge between the magnetic device / product channel and the installation. The completed installation must also be grounded.

**Start-up****Before start-up, make sure that:**

- The device or the installation has no damages or malfunctions.
- All connections (electrical, mechanical, pneumatic) have been made properly.
- The device or the installation is placed and situated correctly.
- All protective covers (if applicable) have been fitted correctly.
- That all objects larger than 10mm are blocked from entering the product channel.
- The device is thoroughly cleaned, internally and externally.
- The product does not fall into the magnet device, from a greater height than 10 meters.
- There are no other sources of danger present.

**During start-up, make sure that:**

- The device or the installation has no damages or malfunctions.
- All other parts of the device or installation function as described.



## Maintenance

Magnetic systems attract Ferromagnetic particles. Regular cleaning is essential. A clean magnet functions considerably better

*All parts are best cleaned with pressurized air and/or a soft cloth. It's also possible to deep clean with special cleaning fluids that do not harm the material.*

*Ensure that these fluids do not contaminate the product*

Regularly check that all warning pictograms and the identification plate are present at the correct locations on the device. If warning pictograms or the identification plate should get lost or damaged, immediately apply new ones to the original locations.

Always inform operating personnel regarding planned inspections, maintenance, repairs or if attending to breakdowns.

Besides cleaning the magnet core, the electro bullet magnet is low in maintenance cost and labour. However, wear may occur to the magnet due to the friction with the raw product.

The maintenance works should be done while the bullet magnet is inoperative and the magnet is switched off.

**Attention:** turn off the magnet during maintenance and/or cleaning works.

### NORMAL MAINTENANCE ACTIVITIES ARE INDICATED BY THE ICONS BELOW:

#### Inspection:



- Daily check the magnet visually on broken or worn parts!
- Daily check whether the magnet core is overloaded with ferromagnetic particles between two cleaning cycles. If this is so, then shorten the period between two cycles.
- Daily inspect on missing or broken warning pictograms.

#### Cleaning:



- Always wear a mouth cap and safety glasses during cleaning!
- Magnets attract dust and Fe parts. Clean the electro magnet daily, or more often when necessary.
- The magnet core has to be cleaned of Fe parts daily or more often when necessary, to make sure that the magnet never gets overloaded with ferromagnetic material and therefore functions optimally as Fe separator.

#### Lubrication:



- Lubricate the door hinges regularly to avoid wear.
- *For food products, only lubricate the bearings under the core magnet with grease that is food-proof.*

**Replace / Revise:**

- Check Replace (wear) parts immediately if broken or periodically according to its replacement schedule. This scheme is dependant of user conditions, and therefore has to be made with experience data.
- Also replace any warning pictograms immediately if they are damaged or lost.



Always inform operating personnel well in advance regarding planned inspections, maintenance, repairs and when attending to faults or breakdowns.  
Make someone responsible who also exercises supervision.

**Cleaning & ATEX**

To prevent explosion risk, avoid dust clouds and the build-up of dust layers.  
If dust particles or layers heat up they may ignite and burn. This in turn can ignite airborne dust clouds and cause an explosion.

## Malfunctions/Service

	<b>CAUTION!</b>
	<p>Improper handling of the magnet device may lead to damages. Potential damage to body and property!</p> <ul style="list-style-type: none"> <li>Any repair to GOUDSMIT magnet devices may be performed by qualified personnel only.</li> <li>Be aware that permanent magnetic material attracts ferromagnetic material with great force when it gets in reach of the magnetic field</li> <li>Consult GOUDSMIT MAGNETIC SYSTEMS customer service</li> </ul>

## Malfunctions

In case of malfunctions, consult the following table in order to determine the cause of the malfunction and its possible remedy. In case a specific malfunction can't be found in the table, consult the GOUDSMIT Magnetic Systems customer service.

Malfunction	Possible cause	Possible remedy
Magnet does not separate ferromagnetic (Fe) particles out of the product flow, or separates them badly	Magnet is overloaded with Fe parts	Clean the magnet core from Fe parts. It will now attract new Fe parts easier
	Not separated particles are not ferromagnetic.	Check that particles expected to be separated are ferromagnetic using a small permanent magnet.
	Ferromagnetic parts within the range of the magnet reduce the Fe separation capacity.	Check the range of the magnet, using a small piece of steel. Replace ferromagnetic parts in the range of the magnet by non-magnetic ones, like stainless steel or aluminium
	Overflow product.	Do not exceed the flow rate capacity stated in the specifications.
	Magnet is not electrically connected and or switched ON	Connect electrical supply and or switch on the magnet
Production stops	Overheated magnet ( $T > T_{alarm}$ ) while the magnet core is overloaded by Fe parts	Let magnet cool down and clean the magnet of caught Fe parts more often
	Overheated magnet while no or not enough product flow over the magnet core	Let magnet cool down and switch off the electro magnet during production stops.
	Opening of door during production	Never open the door during production and shut off power supply before opening
Flap inside valve box does not move, or moves badly	Flap is damaged and clamps against valve box housing	Repair flap and or valve box
	Some object got stuck between flap and valve box housing and obstructs movement	Remove object, check and if necessary repair damage.

## Customer service

Please have the following information available if you require customer service assistance:

- Identification plate (complete)
- Type and extent of the problem
- Time the problem occurred and any accompanying circumstances
- Assumed cause

## Spare parts

As a result of the robustness and quality of our products the device possesses high operational reliability.

When however a specific component requires replacement, the correct component can be ordered by quoting the type number stated on the *identification plate* or on one of the drawing(s) added to this user manual in the added data sheet.

The spare parts are mostly wear parts, such as:  
the cone on the magnet core, the door rubbers, the pneumatic cylinder of the valve box, and the pneumatic parts as solenoids in the control box.

Following mutual consultation Goudsmit magnetic systems will arrange rapid and correct delivery.

## **Storage and Dismantling**

### **Storage:**

If the device will not be used for a long period of time, we advise to store the device in a dry, safe place and to conserve fragile and/or sensitive parts.

### **Dismantling / scrapping:**

On scrapping and/or disposal of the device's parts separately, take into account the different nature and dangers of the components (magnets, iron, aluminium, electrical parts, insulating materials, etc.) and ensure safe disposal. Preferably entrust the task to a specialised company, and always observe the local regulations in regard to disposal of industrial waste.