

DOC.NR.	REV	DATE	BY	DESCRIPTION
GM16508	-	25-9-2019	PV	ORIGINAL DRAWING

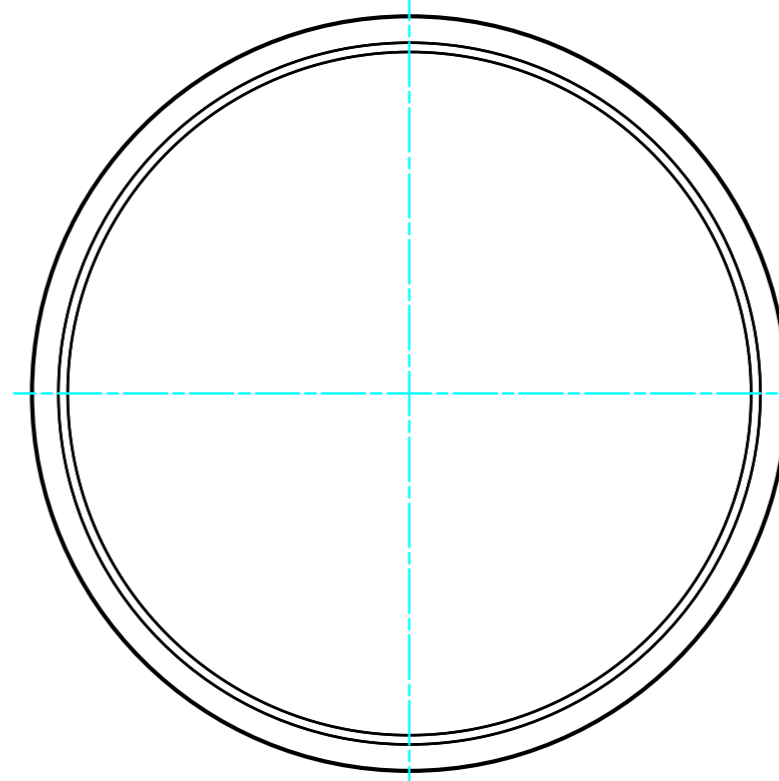
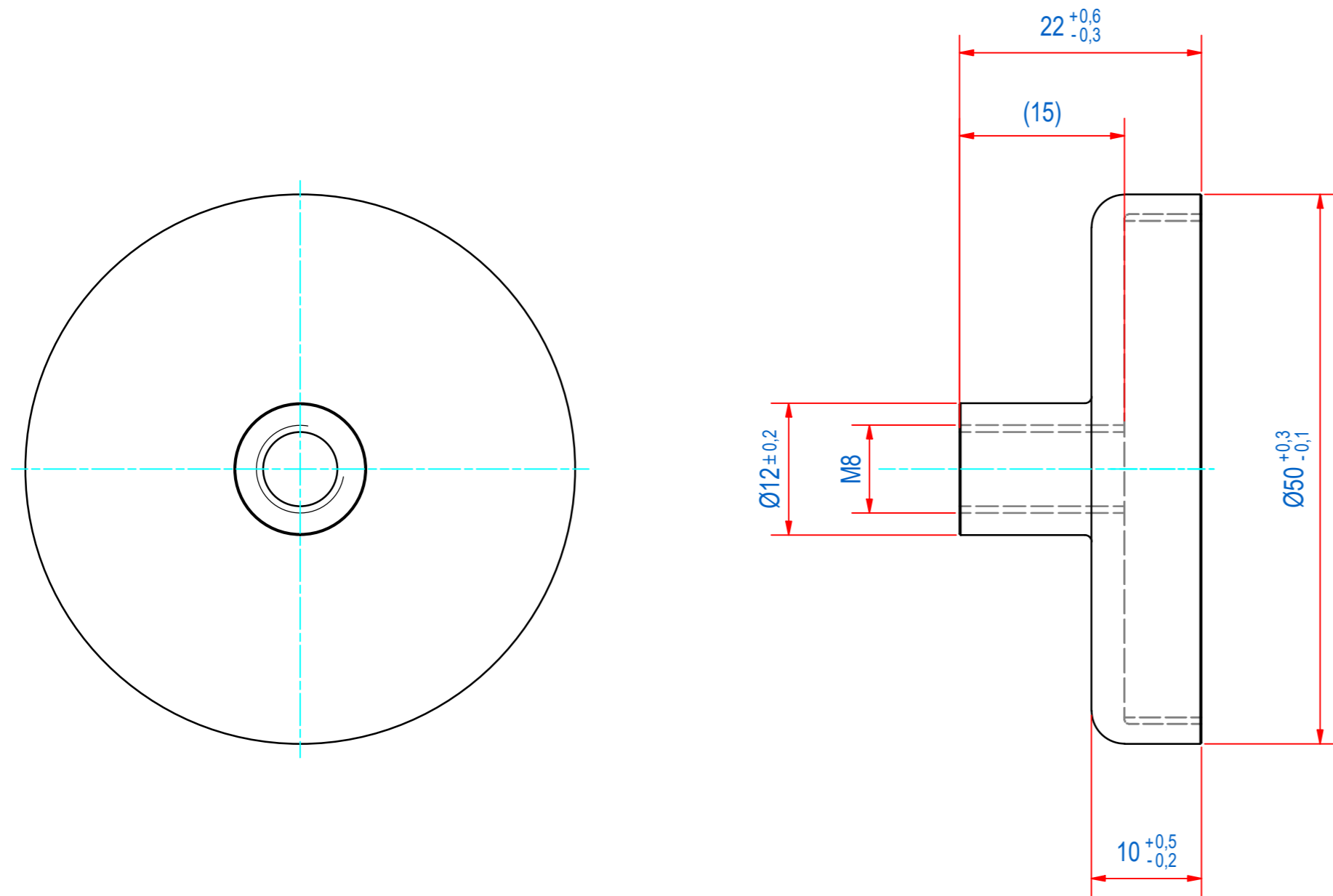
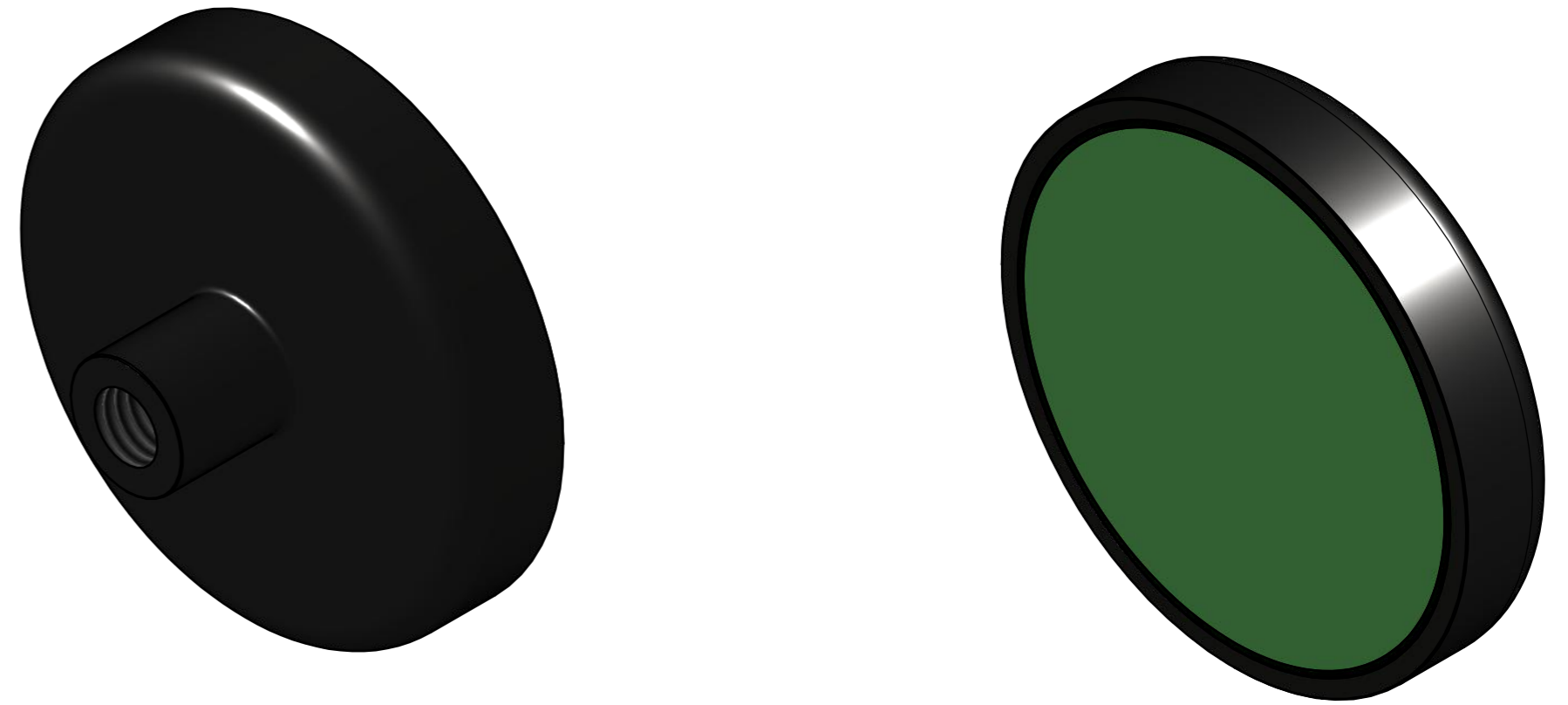

SURFACE TREATMENT: ZINC PLATED

RAW MAT.	1	Quantity	Material Number	Material Description	Length (mm)	Width (mm)
Sheet:	A2	Extra info:	POTMAGNET FERRITE		General tolerance: ISO 2768- mK	
Drawn:	PV	Weight (kg):	0,15		Drawn according: ISO268; ISO1101; ISO2553	
Date:	23-9-2019	Status:	Released		Customer reference number:	
Spare part:	False	Source:			Document number: GM16508 Doc.Rev: -	
Quick search:	POTGM	<small>© All rights reserved. Reproduction is not permitted without written permission of GOUDSMIT Magnetic Systems BV</small>		Part number: GM16508 Rev: -		
Description:	PM-TB-F-SG-D50x10x22xM6			GM16508		