

User Manual

Neoflux® auto-cleaning Cleanflow magnet, series SECC

Automatic cleaning Fe separator by permanent magnetic force

Suited for removal of ferromagnetic (like iron) parts out of powders and granulates.
Not suited products that have a bad flowing capacity.

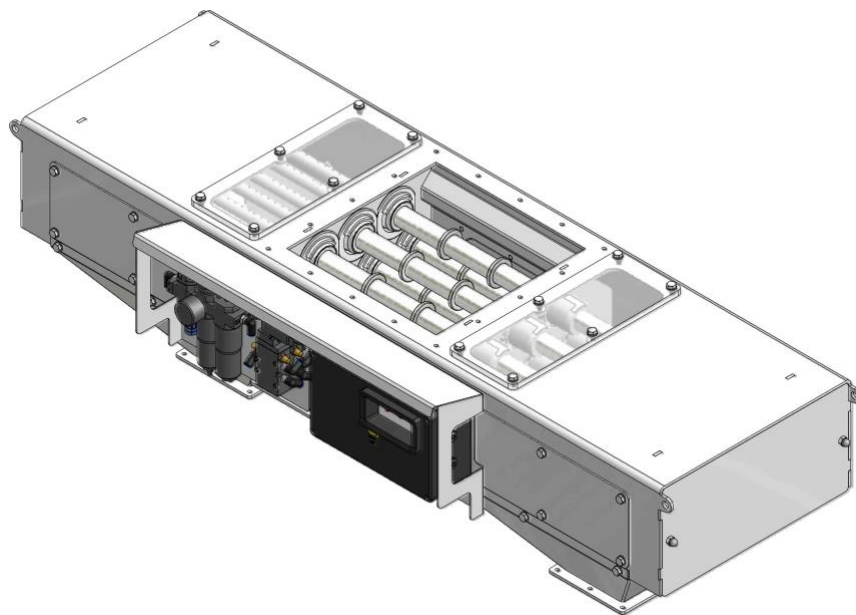

*The descriptions and pictures in this manual, used for explanation, may differ from your execution.
We have enclosed the as-built drawing of the delivered article.*

GOUDSMIT Magnetic Systems B.V.

P.O. box 18
Petunialaan 19
The Netherlands

5580 AA Waalre
5582 HA Waalre

Tel.:
Internet:
E-mail:

(+31) (0)40 221 32 83
www.goudsmitmagnets.com
info@goudsmitmagnets.com



Error! Use the Home tab to apply Kop 1 to the text that you want to appear here.

Versions overview of standard manual

Version	Date	Description
1.0	11-1996	First saved version of this manual
2.0	01-2004	Complete renewed version
2.1	08-2007	1. Revision page added 2. Remarks regarding ATEX added (pages 7, 8, 9, 22 en 27) 3. Remarks regarding cleaning and greasing of magnet bars added.
2.2	01-2009	Chapter Troubleshooting changed to Malfunctions/Service
3.0	08-2009	Specification sheet and declaration by the manufacturer separated from manual
3.1	04-2011	1. LOGO parameter adjustment explanation changed to newest LOGO execution 2. Explanation added of how to copy LOGO program from LOGO to Eprom (p.25)
4.0	07-2012	Atex remarks added
4.1	11-2012	Remarks on grounding of tubes added
4.2	06-2014	Description ATEX ambient temperature range Ta added
4.3	04-2018	ATEX Gas markings added
4.4	06-2018	Further information added for the extension of the ATEX for Gas environment

Introduction

Read this manual and make sure that you fully understand its contents before commissioning and operating the machine.

If you have any queries or require further explanation regarding any subject related to the machine, please do not hesitate to contact **GOUDSMIT Magnetic Systems B.V.**

All technical information contained in this manual, together with any relevant drawings and technical descriptions we supply, remain our property. It may not be duplicated or disclosed without our prior written permission.

The user manual can be ordered together with the device description and/or the article number as well as the order number (ORxxxxxx).

- This manual and the declaration by the manufacturer are part of the machine.
- They must remain with the machine, even if it is sold.
- The manual must be made available to all operators, service technicians, and others who work with the machine throughout its life cycle.

List of contents

Versions overview of standard manual	2
Foreword	Fout! Bladwijzer niet gedefinieerd.
List of contents	4
General	Fout! Bladwijzer niet gedefinieerd.
This Manual	Fout! Bladwijzer niet gedefinieerd.
Ferromagnetism.....	Fout! Bladwijzer niet gedefinieerd.
Conditions of supply and guarantee.....	Fout! Bladwijzer niet gedefinieerd.
Delivery.....	Fout! Bladwijzer niet gedefinieerd.
<i>General</i>	Fout! Bladwijzer niet gedefinieerd.
<i>Identification plate</i>	Fout! Bladwijzer niet gedefinieerd.
<i>ATEX Markings (if applicable)</i>	Fout! Bladwijzer niet gedefinieerd.
<i>ATEX explosive zone measures</i>	Fout! Bladwijzer niet gedefinieerd.
Safety	Fout! Bladwijzer niet gedefinieerd.
General.....	Fout! Bladwijzer niet gedefinieerd.
Danger of gas and dust explosions.....	Fout! Bladwijzer niet gedefinieerd.
Danger of magnetic field.....	Fout! Bladwijzer niet gedefinieerd.
Danger of high voltage.....	Fout! Bladwijzer niet gedefinieerd.
Device description	13
Intended use / user indications	13
Deliverable specials.....	14
Working principle	15
<i>Automatic Fe disposal</i>	16
Construction	18
<i>Pneumatic parts</i>	19
Installation	20
Transport and placing procedures	20
Magnet bar protection.....	21
Pneumatic connections.....	22
Electrical connections general	Fout! Bladwijzer niet gedefinieerd.
<i>Electrical connections & EX</i>	Fout! Bladwijzer niet gedefinieerd.
Gaskets / grounding.....	23
Siemens LOGO!	24
<i>Connecting the LOGO!</i>	24
<i>Standard LOGO! program</i>	25
<i>Changing the Fe disposal interval time in LOGO!</i>	25
<i>Saving the new interval times from the LOGO! to the eprom</i>	27
Startup	28
Checks before and during start-up.....	28
Maintenance	Fout! Bladwijzer niet gedefinieerd.
Magnet bars.....	29
<i>Magnet bar tubes</i>	30
<i>Exchange / revise magnet bars</i>	30
Cleaning & ATEX.....	30
Malfunctions/Service	31
Spare parts	Fout! Bladwijzer niet gedefinieerd.
Storage and Dismantling	Fout! Bladwijzer niet gedefinieerd.

Error! Use the Home tab to apply Kop 1 to the text that you want to appear here.

General

This manual contains information for the correct operation and maintenance of your device. It also contains instructions for avoiding possible injury and serious damage and it allows a safe and as trouble-free functioning of the product as possible. Read this manual thoroughly before putting the device into operation, familiarise yourself with the operation and control of the device and follow all instructions precisely.

- *The data published in this manual is based on the available information at the time of delivery. This is issued subject to later amendment.*
- *We retain the right to amend or modify the construction and/or model of our products at any time whatsoever without any obligation to modify any previously supplied products accordingly.*

Ferromagnetism

The working principle of the device rests on (Ferro)magnetism.

Ferromagnetism is the basic mechanism by which certain materials such as iron cobalt and nickel can get magnetized when exposed to an externally applied magnetic field. Materials that remain magnetized after the external magnetic field is removed, are called permanent magnets. Most magnetic materials lose their magnetism after the external magnetic field is removed. Most alloys of iron, cobalt and nickel are magnetic. However, some stainless steel alloys like AISI304 or AISI316 are only slightly magnetic.

Because in most cases it will be Fe parts that will be Ferro-magnetically influenced, we will use the term 'Fe' in this user manual when we mean ferromagnetic material

Error! Use the Home tab to apply Kop 1 to the text that you want to appear here.

Conditions of supply and guarantee

The conditions of supply are the “**General Conditions for the supply and erection of mechanical, electrical and electronic products**” (SE01), published by **Orgalime**, in Brussels.
These conditions can also- if desired – be requested by writing to Goudsmit Magnetic Systems B.V., as also mentioned in our written quotation.

The guarantee prescriptions are mentioned in these conditions.

The guarantee on your equipment will be void if:

- Service and maintenance are not performed in accordance with the instruction manual or by servicemen who are not especially trained to do the work. We strongly recommend that specific magnetic service and maintenance be carried out by Goudsmit personnel).
- Modifications are made to the equipment without our prior written permission.
- Non-original parts or non 100% exchangeable parts are used.
- Lubrication products other than those prescribed are used.
- The equipment is used injudiciously, incorrectly, negligently or not in accordance with its intent and/or purpose (see chapter “Intended use / user instructions”).

All parts that are subject to wear are excluded from the guarantee.

Remaining remarks / warnings

- Use the device only for the application for which it has been designed (see chapter “*Intended use / user instructions*”).
- Use the device only when it is in technically perfect condition, and ensure that all protective hoods or inspection covers, including all safety circuits, have been fitted and installed in the correct manner.
- Ensure that device maintenance is appropriate and in accordance with the instructions provided in this user manual.
- Any eventual faults, in particular those that may influence safety, should be attended to immediately and remedied before renewed operation. Should you, after estimating the risks of an unsolved fault, still think it is safe to keep the device into operation, then warn the operators and maintenance staff of these faults and the danger(s) caused by these faults.

Error! Use the Home tab to apply Kop 1 to the text that you want to appear here.

Delivery

General

Check the shipment immediately on delivery for:

- Possible damage and/or shortcomings as a result of transport. If so, ask the transporter to draw up a transport damage report.
- Completeness of the delivery/deliveries, the absence of anything (additionally) ordered.

Always immediately contact **GOUDSMIT magnetic systems** in the event of any damage and/or mistaken delivery.

Identification plate

On the device you will find an identification plate as pictured below. **Information on this plate is of great importance in case of service.** That is why we advise to maintain this plate on the device at all times. Ensure that it is always legible by cleaning regularly.

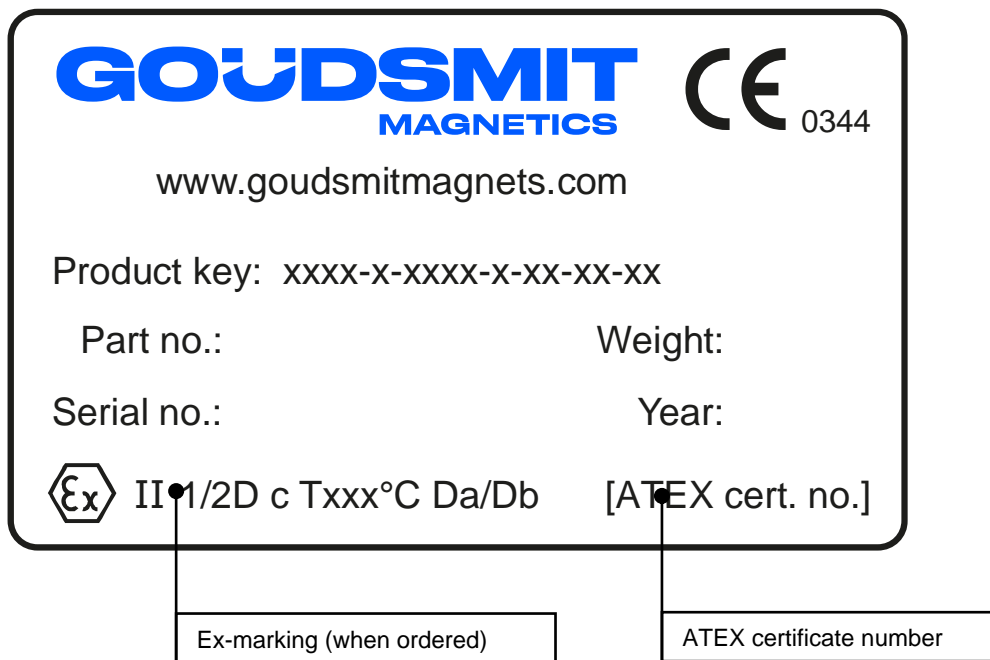



Don't forget to make note of both the Serial Number and the Item number in case of breakdowns or delivery of spare parts.

If your identification plate is damaged, contact us and we will send you a replacement

Error! Use the Home tab to apply Kop 1 to the text that you want to appear here.

ATEX Markings (if applicable)

When the equipment is suitable for use in potentially explosive atmospheres (ATEX) the type plate will feature an Ex Marking specifying the environment for which the equipment is suitable (gas or dust), the specific device category and other criteria that the equipment satisfies.

- Ex marking example dust:  II 1/2D Ex h T105°C Da/Db
- Ex marking example gas:  II 1/2G Ex h IIB T4 Ga/Gb

Explanation:

- II explosion group (I is underground mining, II is other)
 - G/D Type of ATEX environment G(as) or D(ust)
 - 1/2D Equipment Category (Ignition protection level: 1=very high, 2=high, 3 = normal)
- or 1/2G

Equipment category	Dust			Gas		
	1D	2D	3D	1G	2G	3G
Suited for ATEX zone(s)	20 (21 & 22)	21 (22)	22	0 (1 & 2)	1(2)	2

[inside device / outside device]

- h Type of Ex protection
 - c = constructional safety
 - t = protection by enclosure
 - h = non-electrical equipment (protection method not specified further)
 - T105°C Maximum surface temperature for dust atmosphere
 - T4 Temperature class for gas atmosphere
 - IIB Gas group where the equipment is suitable for
 - Da/Db Equipment Protection Level (EPL).
- or Ga/Gb

EPL	Dust			Gas		
	Da	Db	Dc	Ga	Gb	Gc
Suited for ATEX zone(s)	20 (21 & 22)	21 (22)	22	0 (1 & 2)	1(2)	2

[Da inside device / Db outside device]

- Ta Ambient temperature range; only displayed when the range deviates from the standard temperature range for ATEX of -20 ... +40°C

If the device is externally certified, then the ATEX certificate number is added to the type plate. Next to the CE mark the identification number of the Notified Body that certified our ATEX quality assurance system is displayed.

Error! Use the Home tab to apply Kop 1 to the text that you want to appear here.

In case the equipment contains no 'own ignition sources' and therefore is not under scope of the ATEX Directive, then the equipment will not get an EX marking and will be supplied with a Statement of Exclusion, in which this is stated and also the EX zones are listed in which it can be safely used.

ATEX explosive zone measures

- If the device has been ordered for use in a potentially explosive area, make sure that no higher surface temperature arises than permitted by ATEX.
- The product temperature may not exceed 60°C.
- For ATEX Dust environment:
 - The ignition temperature of the dust must be greater than 157°C.
 - The smouldering temperature of a dust layer must be higher than 180°C.
 - No dust layers thicker than 5 mm may accumulate on the equipment.
- For ATEX Gas environment:
 - The occurring gasses or vapours must be in temperature class T4, T3, T2 or T1.
 - The occurring gasses must have an ignition temperature higher than 150°C.

The ATEX marking on the Goudsmit identification plate only applies to the product produced by Goudsmit Magnetics.

**Make sure no particles > 10 mm are present in the product flow. These can damage the magnet or extractor bars or cause impact sparks.
If necessary install a mechanical filter (sieve) before the separating equipment!**

- The ATEX certified magnetic device requires additional purchase parts to be certified to the ATEX Directive. This includes control units, connection box(es), switch(es), sensor(s) and pneumatic parts, etc. Make sure that these are fitted by qualified personnel!
- If the device is placed in storage or has a longer standstill, make sure the device is emptied and cleaned.
- The device must be grounded. The electrical resistance to earth must be below 1 MΩ. If a gasket is used between the device and the larger installation, provide a means for equalization of potential electrostatic charges with a minimum electrical resistance to the installation of 25 Ω. This can be done by applying a braided bonding cable or other means.
- No paint or coatings may be applied on the inner surface of the product chute.
- On the outside of the equipment no insulating paints or coatings may be applied with a thickness exceeding 2 mm.
- All screw connections inside the device must be secured against loosening.

The ATEX purchase parts are provided with their own ATEX markings.

Error! Use the Home tab to apply Kop 1 to the text that you want to appear here.

Safety

Regularly check that all warning pictograms are still present and legible, and clean if necessary. Make sure that new pictograms are applied at their correct locations if they have been lost or damaged.

General

The device is provided with safeguards where necessary. Make sure every person who comes in contact with the device, wears adequate personal protection (overalls, safety glasses, hearing protectors, helmet, steel-toed safety shoes etc.).

Areas of the device considered dangerous are marked with warning pictograms.

If the device remains easily accessible to persons, then extra safety precautions (e.g. fencing) must be installed. When safeguards are not possible, make sure clear instructions are given to people using the device.

Danger of gas and dust explosions

If this device is made according to ATEX category 1/2D or 1/2G (acc. to ATEX equipment directive 2014/34/EU) it can be used in the corresponding zones. See the chapters about ATEX markings and measures for details. The Ex category is then indicated on the identification plate.



Make sure that the equipment is suited for the correct ATEX environment (gas or dust) and has the right equipment category for your application.



Danger – gas or dust explosion!

Also check if **the identification plates of mounted parts** show the correct Ex-category for the Ex zone in which the device will be used.

Error! Use the Home tab to apply Kop 1 to the text that you want to appear here.

Danger of magnetic field

The magnets generate a powerful magnetic field that strongly attracts ferromagnetic (Fe) materials. Always take into account that these materials may suddenly be drawn towards the magnet, very powerfully. This applies to steel workbenches and steel tools, but also to Ferromagnetic materials carried on your person, such as coins in your wallet or your keys. Make use of non-magnetic tools and workbenches fitted with a wooden worktop and preferably a non-Fe frame (for instance stainless steel).



Always be aware that Ferromagnetic parts will be attracted -- even personal items - if you are closer than 0.3 meter to a magnet.



Danger - strong magnetic field!



People fitted with pacemakers should on no account enter the magnetic field (within a radius of 1 meter).



Prohibited for people with pacemakers!



Credit cards, chip cards, computer disks/tapes, computer screens, watches, etc. may be damaged or destroyed if they enter the magnetic field (within a radius of 0.5 meter).



Danger for magnetic cards!

Error! Use the Home tab to apply Kop 1 to the text that you want to appear here.

Danger of high voltage

When installing and electrically connecting the device, make sure the activities are performed by qualified personnel.



Switch off the electrical power supply before performing activities to the device!



Danger – Risk of an electric shock!

Always use the main power switch (on the control box) to switch off the installation in the event of a dangerous situation.
Do not restore power until the dangerous situation has been resolved!

Error! Use the Home tab to apply Kop 1 to the text that you want to appear here.

Device description

Intended use / user indications

Material stream

The Neoflux® auto-cleaning cleanflow magnet SECC is suited for separation of ferromagnetic (Fe) parts out of free flowing powder and granular material, grain size up to 10 mm, such as flour, sugar, coffee beans, plastics, ceramics, etc.

Not suited for: (moist) material streams that are sticky and/or badly flowing

Abrasive materials speed up the wear of the magnet bar tubes and other parts, such as sealings between product channel and Fe disposal side parts.

Fe part size

Suited for material streams with Fe particles of 30µm and larger, depending on magnet strength quality. See product specs in the appendices for exact Fe parts size specification.

Product should be free of Fe part size and weight that can cause damage to the magnet bar tubes. Mechanical or other sieving of larger parts is advised.

Foreign part size

Foreign part (like other metals) size that can cause damage to the magnet bar tubes have to be filtered out.

Mechanical or other sieving is advised.

Temperatures

Suited for material stream temperatures of -20 °C to +60 °C or more, depending on used magnet type, and for surrounding temperatures of -20°C to +40°C.

For exact values see specific article specification sheet

The magnet is to be protected against higher temperatures than prescribed, because the magnet might **lose magnetic force permanently** when exposed to high temperatures

Air pressure

The (relative) over-pressure in the product channel has to be under 0.2 bar.

The (relative) under-pressure in the product channel has to be under 0.5 bar.

Free space

Make sure that there is approximately 1 meter of free space around the SECC clean flow magnet device to perform and ease the inspection and maintenance operation. At one head side, this should be at least 1 magnet bar length, because of possible exchange of magnet bars.

Noise level

The noise level of the device is less than 70 dB at delivery. Should it become higher, then the device has to be immediately checked on a failure, a breakdown or severe wear.

* ferromagnetic: see chapter GENERAL/[Ferromagnetism](#)

Error! Use the Home tab to apply Kop 1 to the text that you want to appear here.

Vibrations

The magnet is to be protected against strong external vibrations, because the magnet might **lose magnetic force permanently** and or the brittle ceramic magnet material might break.

The only vibrations caused by the clean flow magnet SECC are forced by the moving magnet bars. The product channel in which it is placed has to be stiff enough to damp out the (relatively small) forces of the moving magnet bars.

Cleaning

Minimum 2x per day (more often when lots of Fe is in the product flow en less when proven possible) cleaning (Fe disposal) of the device is advised for an optimal magnetic separation, and to prevent for Fe accumulation on the magnet bar tubes and the problems that can be caused by that. Clean magnets have the best Fe separation result. So, make sure to clean a little more than assumed necessary, to achieve a satisfactory result of the clean flow magnet device.

For dirt cleaning: see chapter [Maintenance](#)

Deliverable specials

Higher product temperatures

For high product temperatures there is the possibility of using other magnet material than the standard Neoflux® magnets. See product specs in the appendices.

Abrasive products

If you have an abrasive product, we can supply the magnet bars and /or inside housing with a protective coating, like for instance a tungsten carbide coating.

Use in FOOD product flows

The SECC can be adapted so that it can be used in your specific food stream. It's standard execution already has little gaps or dead spots in the, already complete SS AISI304, product channel. The product channel (or even complete housing + magnet bars) can be delivered in gap-free SS AISI304 or AISI316, or in combination with other – for instance prescribed or delivered by customer – food improved materials. Surface treatments like electrolytic polishing, staining, etc. are naturally possible.

ATEX

IF components are built on or built in to the Atex approved magnetic device, by the customer or third party, this can void Atex suitability.

It is the responsibility of the customer to take the right precautions for use in an Atex zone, like regular cleaning to prevent for thick accumulating dust layers, and suitable grounding measures.

Read this manual thoroughly for all ATEX measures.

If you desire an ATEX declaration with the device, it has to be especially ordered. An additional cost will be charged!

Error! Use the Home tab to apply Kop 1 to the text that you want to appear here.

Working principle

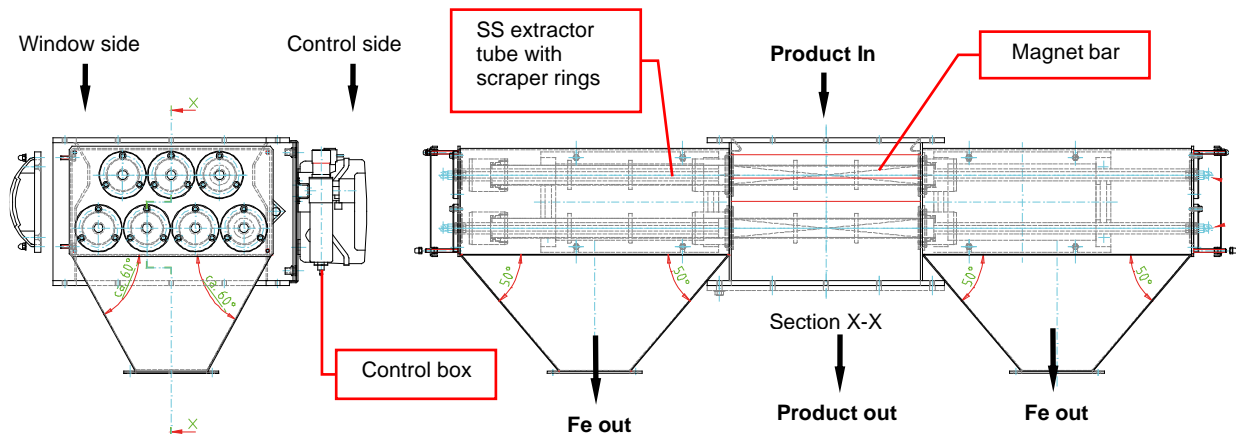

Drawing: SECC 3+4 magnet bars

- The SECC continuous cleaning cleanflow magnet is designed for separating ferromagnetic* parts out of a vertical product flow in a pipe line, without having to interrupt the product flow □ the magnets always remain in the product channel.
- The magnetic separation is achieved by 2 layers of **Neoflux® magnet bars** placed above each other cascade-wise.
- Inside the bars there is a magnet package that cannot move and will thus always stay in the product channel. A SS tube can be moved over the magnet package to the left or right by air pressure to move out the caught Fe parts at fixed intervals.
- The Fe parts will be attracted by the magnets, get caught and stick onto the **Stainless Steel (SS) tubes**, while the cleaned product flows further.
- Product will fall through the product channel, passing minimum 1 magnet bar.
- The separated Fe parts will remain on the bars until they will be cleaned of Fe parts via the **Fe-disposal chutes (Fe out)**.
- The cleaning of Fe parts is achieved by moving the magnet bar tubes to the left or right into the Fe disposal chutes (the magnets stay in the product channel!). In the Fe disposal chutes there are no magnets inside the tubes anymore, so the Fe parts will no longer be magnetically attracted and thus fall off and leave the device via “Fe out” chutes.
- The **scraper rings** on the tubes will force the Fe parts to move with the tube, into the Fe disposal chute. The scraper rings also protect the Fe parts from all clinging onto another and so creating a worse loosening in the Fe disposal chute.
- Cleaning of caught Fe parts will automatically take place every x minutes / hours (adjustable), controlled by the control unit on the device. If the 2 magnet layers are moved separately, then there is x/2 minutes time difference (adjustable) between the cleaning of the upper and lower layer.
- Status report is optional when Siemens LOGO! control unit is ordered. This is achieved by sensing the end positions of the magnet bars and so concluding whether the magnet bars still move correctly to the Fe disposal chutes. The status reports can also be sent directly to central control.

Unfortunately, product that sticks onto and in-between the Fe particles, will also fall off with the falling Fe parts, and will thus cause a slight product “loss”.

*ferromagnetic: see chapter General/**Ferromagnetism**

Error! Use the Home tab to apply Kop 1 to the text that you want to appear here.

Automatic Fe disposal

The cleanflow SECC is executed with a **local control unit**, with a Siemens LOGO! logic Module for controlling the magnet bar movements.

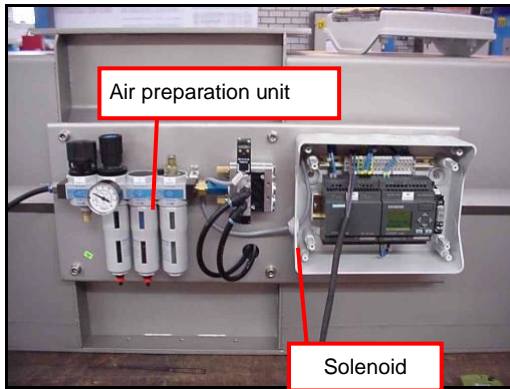

Photo: standard control unit

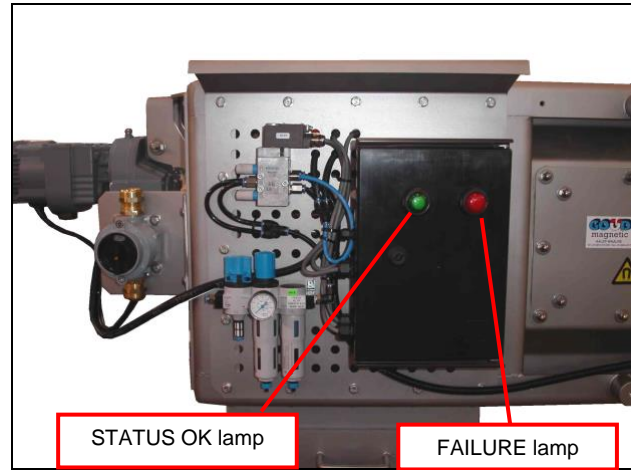
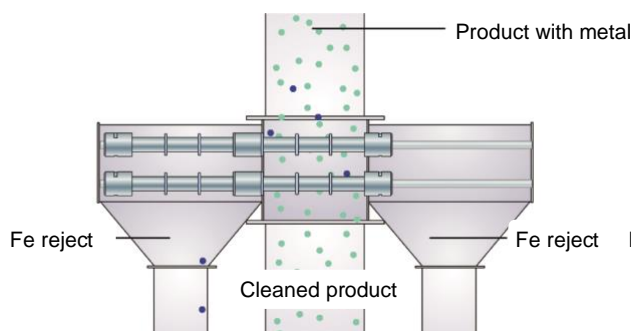

Photo: Ex control + work switch + status report

- The logic program provides an automatic Fe disposal cycle:
- Starting the program can be achieved by supplying power to the LOGO! control unit, stopping by ceasing power supply. An ON/OFF push button or work switch can be used locally for this purpose.
- Every X hours (cycle time depends on Fe contamination) the magnet bar tubes have to be moved towards the left or right (standard setting = 4 hours).
- The caught Fe parts will then be moved along with the magnet bar tubes, into the Fe disposal parts = out of the product channel. Here it will automatically fall off, as they are out of the magnetic field and thus no longer attracted by it.
- The purpose of the Fe disposal cycle is thus to dispose the separated Fe particles outside the product channel.

Below are 2 drawings of the website video are printed.



Drawing: product (green) with Fe parts (blue)

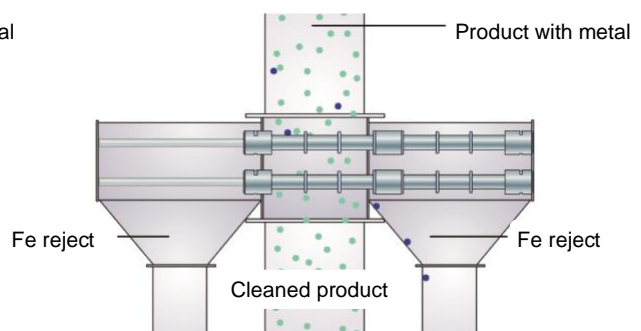

Drawing: Fe disposal in right disposal chute

Error! Use the Home tab to apply Kop 1 to the text that you want to appear here.

The Fe disposal cycle of the SECC is automatic and **continuous**. This means the product flow needs never to be stopped, because the magnets at all times remain inside the product channel to actuate their magnetic separation function!

Advantages automatic continuous Fe disposal:

- During the Fe disposal cycle it is not needed to interrupt the product flow
- Because of this you can easily more often perform a Fe disposal cycle, which is better for the magnetic separation of Fe parts, because a clean magnet bar functions better than a contaminated one.

Disadvantages automatic continuous cleaning:

- Not completely dust-tight product channel. Some product loss from flowing product is inevitable, especially during movement of the magnet bar tubes to the left or right in a Fe disposal action.

Error! Use the Home tab to apply Kop 1 to the text that you want to appear here.

Construction

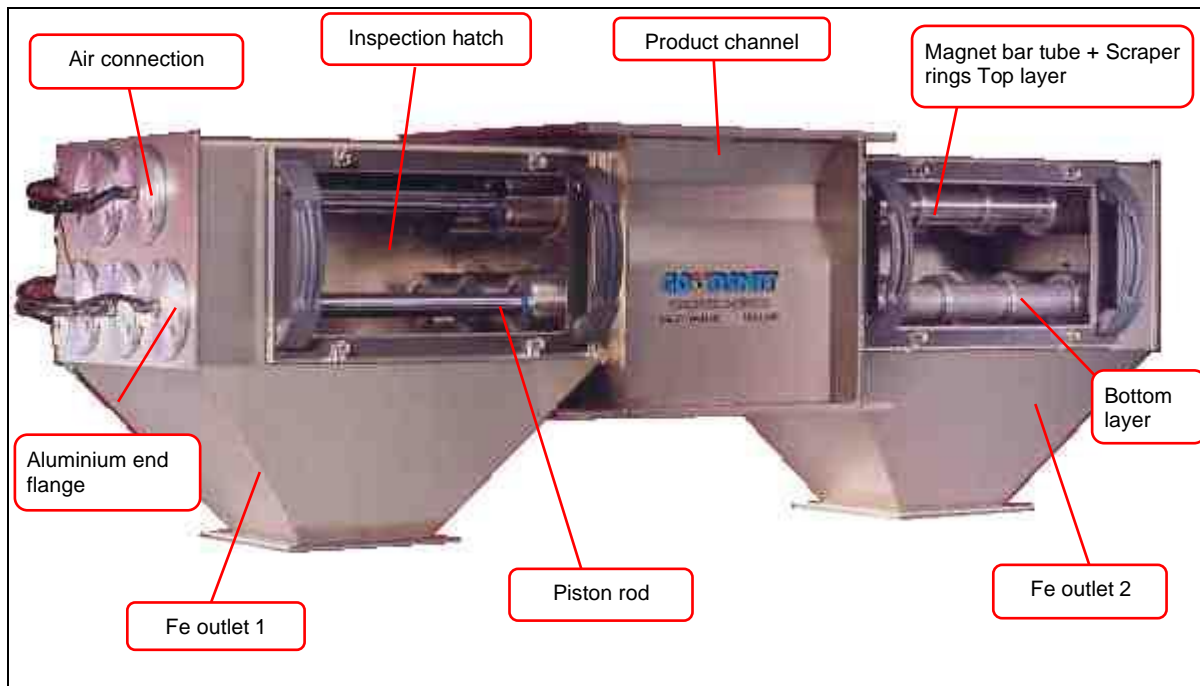

Photo: continuous cleaning Cleanflow SECC 2+3 bars

- The SECC has **2 layers of Neoflux® magnet bars**; upper layer has 1 bar more than the lower layer, numbers depends on inlet size.
- The bars are pneumatically actuated cylinders, with a **magnet package** on the cylinder rod. Outside, the bars have a thin-walled (0.8 mm) SS magnet bar tube.
- Every magnet bar is mounted in 2 **aluminium flanges**, which are fixed at both head sides of the housing. In each flange the **air connection** is mounted, for the actuation of the magnet bar.
- In each **Fe outlet** channel and sometimes in the product channel, an **inspection / maintenance hatch** is placed. Through these one can check the magnet bar movements, but they are also useful when a magnet bar has to be taken out, and during maintenance actions.
- The product chute is executed with **flanges** for mounting the in and outlet pipes.
- The Fe outlet chutes are executed with flanges for mounting the Fe outlet pipes
- At the non-inspection side the **Siemens LOGO!**, including the **air preparation unit** and **2 pneumatic solenoids** are mounted: The air goes from the air preparation unit to the solenoids and then to the magnet bars.

Error! Use the Home tab to apply Kop 1 to the text that you want to appear here.

Pneumatic parts

- The 2 solenoids for actuating the magnet bars (1 solenoid per layer), are placed in or near the LOGO! module on the control plate.
- The air preparation unit is also placed on the control plate and exists of subsequently:
 - On/off valve – can be locked by padlock – releases air pressure when closed;
 - Regulator;
 - Micro-filter.

Air preparation unit



- 1 On/off valve
- 2 Regulator
- 3 Micro-filter

Error! Use the Home tab to apply Kop 1 to the text that you want to appear here.

Installation

Transport and placing procedures

- The device is delivered in a wooden crate. Bolt a lifting lug to each of the 4 corners of the magnet housing flange for stable transport process. Keep each corner on the same level for proper alignment before installation.
- Use proper lifting devices that suit the device's weight. Keep the centre of gravity in consideration. This may be not in the middle of the device!
- Work safely: create enough work space, use proper scaffoldings, ladders and lifting devices that suit with device's weight.

Read the weight of the clean flow magnet on the identification plate.

- Bolt the flanges of the device securely to the inlet and outlet flange of your product channel. This also applies to the Fe contaminant outlet of your installation, if applicable. Improper alignment and loose assembly may cause leakage of raw product. Thereby ensure that the device is earthed.
- Check that all the screw connections inside the device are secured against loosening.
- Ensure that the channels are strong enough to support the weight of the clean flow magnet and raw product in it. If these are not strong enough, then one should make sure that they are made strong enough before further installation.
- It is best to install the clean flow magnet in a well reachable height to the operators. A good height eases all operation, inspection and maintenance work.
- Avoid any impact during transport to prevent damage, especially to the magnet bar tubes. Damage to the tubes can cause magnets to "stick" in the surrounding tubes.
- Clear the area under the magnet during transport.
- Ensure that the product entering the drum magnet, does not fall from a greater height than 10 meters. This is especially applicable in an EX zone !
- Test that all the magnet tubes inside the device are grounded
- Clean the interior and exterior thoroughly before putting into operation.

Error! Use the Home tab to apply Kop 1 to the text that you want to appear here.

Magnet bar protection

- The cleanflow SECC has fragile magnet bar tubes in the magnet bars. The tubes have a material thickness of only 0,8 mm, which has the advantage of ensuring a high grade of Fe separation. Disadvantage is that large, heavy Fe and/or other parts in the product flow can however create bumps in the tubes.

Ensure that large, heavy parts are filtered out of your product flow before it passes the cleanflow!
Advise: place a sieve (filter) in front of the SECC!

- During maintenance or cleaning operation it is also advised to be very careful with the magnet bar tubes to avoid damage.

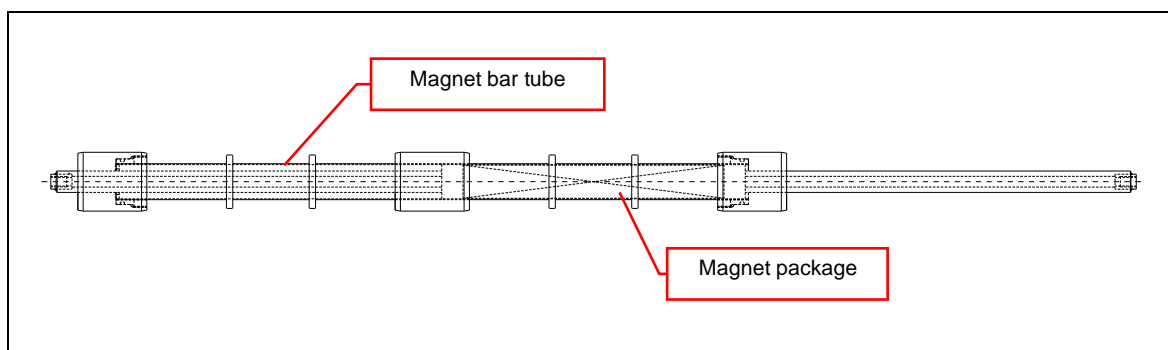

Drawing: magnet bar – magnet bar tube moves over a magnet package

- When a magnet bar tube is damaged it is probably difficult or impossible to move the magnets inside the tubes;
- When this occurs it is advised to revise the bar(s) or (preferred) to let the magnet bar be revised by or order a new one at Goudsmit to avoid further damage to the magnet bar and or other clean flow parts.
- Also see chapter [Maintenance](#)

Damage to the magnet bar tubes and/or damage caused by damaged tubes (when used) is not covered by guarantee.

Error! Use the Home tab to apply Kop 1 to the text that you want to appear here.

Pneumatic connections

- The air preparation unit is mounted at the non-inspection side of the device.

Air preparation unit



- 1 On/off valve
- 2 Regulator
- 3 Micro-filter

- Connect the air supply to the ON/OFF valve.
- The prepared air is connected from the micro-filter to the solenoids that actuate the magnet bars. **Make sure that the air pressure to the solenoids continuously is max 6 bar.** Well functioning bars must move smoothly at 6 bar, but: *they will not all move simultaneously because of the “slip-stick” effect of air cylinders!*
- After some time – as a result of the use and circumstances – the pneumatic parts of the magnet bars can show some wear. This can cause the bars to need more air pressure for moving. If more than 8 bar is needed, the magnet bars need to be replaced and/or revised. If so, send the bars back for repair to **Goudsmit Magnetic Systems BV**
- Magnet bar revision: see chapter [Maintenance](#).

Error! Use the Home tab to apply Kop 1 to the text that you want to appear here.

Electrical connections general

Make sure that the electrical power supply is switched off while you work on the device and can't be re-enabled without your knowledge.

Make sure that all electrical connections are made by qualified personnel and conform to all the applicable standards. Check that the device is suitable for connection.

The electrical connection values are indicated on the nameplate and/or on the supplied electrical drawings. Before connection, check the supplied devices for the locally valid connected loads and ensure that the appropriate connection cables are designed for the electrical power to be drawn.

Ensure that all electrical connections are checked/tightened after delivery and regularly thereafter (e.g. once a year).

The connection details of the control box supplied (if present) can be found in the enclosed diagrams.

Electrical connections & EX

If the device is placed in an Ex zone, everything you add or change to the device's electrical installation must be executed and documented according to the regulations for the specific Ex zone.

Gaskets / grounding

To prevent the build-up of static electricity, make sure there is metal bridge between the magnetic device / product channel and the installation. The completed installation, including the magnet tubes, must be grounded.

Error! Use the Home tab to apply Kop 1 to the text that you want to appear here.

Siemens LOGO!

- The **Siemens LOGO!-control unit** initiates the movement of the extractor tube.
- The LOGO! is a simple “PLC” module of Siemens. The LOGO! actuates the 2 solenoids; the solenoids control the movement of the extractor tube layers. First the top layer will move and half a cycle later the bottom layer (*LOGO! diagram is added*).

Connecting the LOGO!

- Electrical drawings: see *added diagrams/drawings*

Connect 24 VDC on **L+** and **M** to ground.

If you do not have 24VDC power supply available, but you do have 120/230V-50/60Hz, than you can use power supply unit (Power 1.3) that is mounted next to the LOGO!. It can transform your signal to 24 VDC. In this case connect power to **L1** and the neutral to **N**.

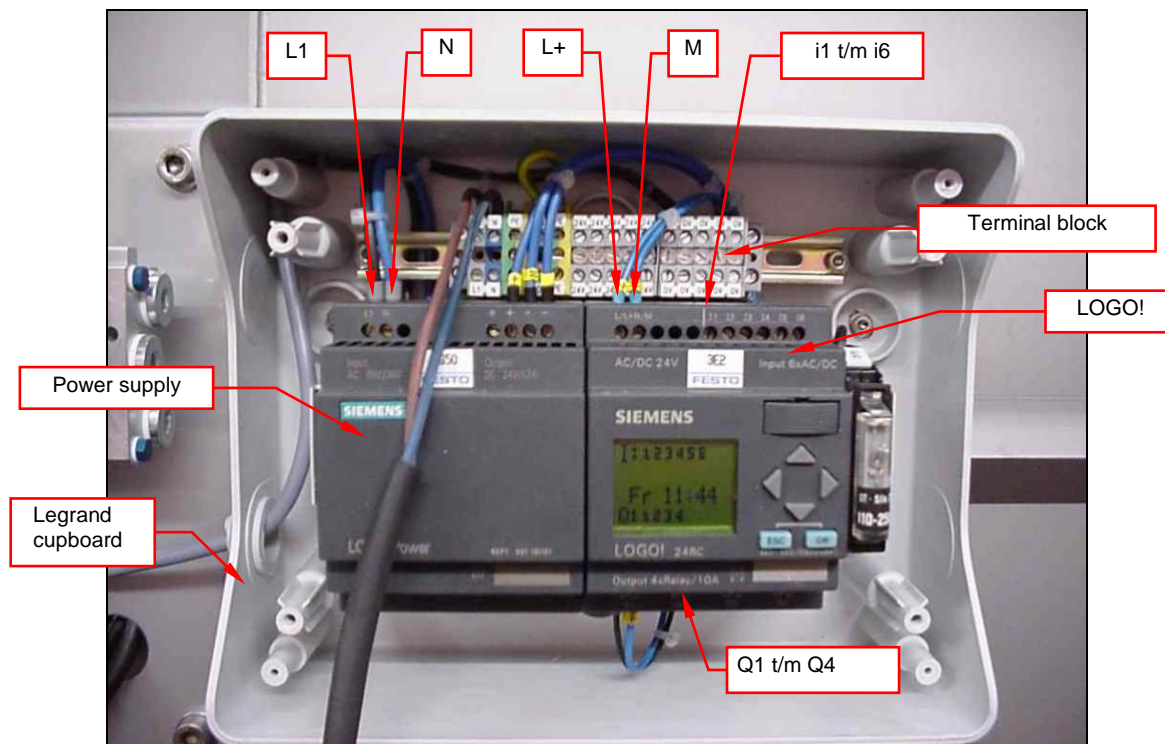

Photo: Siemens LOGO! with 24 VDC power supply in Legrand box

Input

Input (i1 till i6) are not in use.

Output

- Output Q1 energises the solenoid of the top layer magnet bars.
- Output Q2 energises the solenoid of the bottom layer magnet bars

Error! Use the Home tab to apply Kop 1 to the text that you want to appear here.

Standard LOGO! program

The logic program of the LOGO! secures how and when the magnet bar tubes will move to the other side. LOGO! energises the solenoid that makes the magnet bars move. *(LOGO! diagram is added).*

The logic program is also saved on the **EPROM** placed in the LOGO! unit

Damages caused by false changes to the LOGO! program are not covered by guarantee!

Goudsmit always delivers an EPROM with the program in the LOGO!

Sometimes a new program is needed; then we sent a new EPROM:

Loading the new EPROM program is done this way:

- Ceasing power of LOGO!;
- Remove old EPROM;
- Place new EPROM;
- Reset power on LOGO!, which makes that the new EPROM program is automatically loaded into the LOGO!

It is possible to adjust the parameters of the logic program in LOGO!, like the interval time between the Fe disposal movements of the magnet bars (moving left / right):

Changing the Fe disposal interval time in LOGO!

To change the interval time you need to adjust 4 parameters in the LOGO! program:

1. Time between forward and backwards movement of upper row magnet bars (B1)
2. Time between forward and backwards movement of lower row magnet bars (B2)
3. Time before start of 1st Movement of lower row magnet bars (B3)
4. Time before start of 1st Movement of upper row magnet bars (B4)

1. Time between back and forth movement magnet bars (B1)

** It is possible to adjust the parameters without having to stop the program!*

Changing the parameters can be done in mode "Parameters". To get to this mode the following procedure has to be followed from the start screen:



1. Push the button **Esc** and **OK** simultaneously

LOGO! Will go to mode Parameters and you will see:

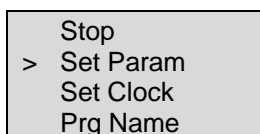

Error! Use the Home tab to apply Kop 1 to the text that you want to appear here.

2. Push ∇ button and go to "Set Param". Push on **OK** to confirm this.

On the screen you will see these lines:

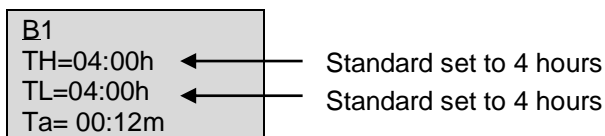

1. Block number with parameter (TH/TL)
2. Set value of this parameter (TH/TL) with his dimension (Hours: minutes: seconds)
3. The actual value of the parameter in the running program (Ta)

The cursor will light up in the B of block B1

3. To change the time push the **OK** button. Cursor will jump to 0 of line **T=04:00h**
4. With button ∇ and Δ you can change the value up/down. Then you can go to the next number and back with buttons $>$ and $<$.
5. Make steps 3 en 4 also for **TL** (set to same value as TH)
6. By pushing the **OK** button you confirm the changed values.
7. Go to next time block (**B4**) with button ∇ .

On the screen you will see these lines:

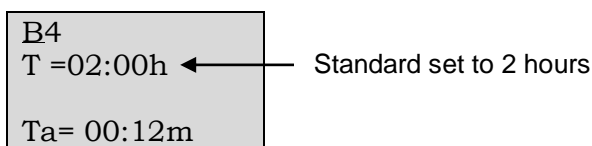

8. Make steps 3 to 6 also for time **T** (set to half value of TH and TL)
9. Make steps 3 to 8 also for Time blocks **B2** and **B3**
10. With **Esc** you will go back to the main menu . You have to push twice **Esc** to come back into you start position.

You are back in the start menu and the cleaning cycle is changed inside the LOGO.

The new set time parameters are not yet saved to the Eprom though!
To save these new parameters to the Eprom: see next page.

Error! Use the Home tab to apply Kop 1 to the text that you want to appear here.

Saving the new interval times from the LOGO! to the eprom

The new interval times can only be changed in the program inside the LOGO! unit. To save the adapted program to the eprom as well, act as follows:

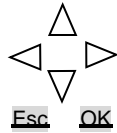

1. Push the button Esc
2. walk to “**Stop**” with the arrows and push OK:
3. walk to “**Yes**” with the arrows and push OK:
4. walk to “**Card**” with the arrows and push OK:
5. walk to “  **Card**” with the arrows and push OK:



```
>Stop
Set Param
Set Clock
Prg Name
```

```
Stop Prg
No
>Yes
```

```
Program
>Card
Clock
Start
```

```
>  → Card
Card → 
CopyProtect
```

 = LOGO!

Error! Use the Home tab to apply Kop 1 to the text that you want to appear here.

Startup

Checks before and during start-up

It is essential to comply with the safety notes in this user manual during start-up!

Before start-up, make sure that:

- the device or installation has no damages or malfunctions;
- all connections (electrical, mechanical, pneumatical) have been made properly;
- the device or installation is placed and situated correctly;
- all protective covers (if applied) have been fitted correctly;
- that all foreign (iron) objects larger than 10mm are blocked from entering the production channel;
- the device is thoroughly cleaned internally and externally;
- the product does not fall into the magnet device, from a greater height than 10 meters;
- That the entire installation, including the magnet tubes, is grounded;
- there are no other sources of danger present.

During start-up, make sure that:

- the device / the installation has no damages or malfunctions;
- all other parts of the device / the installation function as described.

Error! Use the Home tab to apply Kop 1 to the text that you want to appear here.

Maintenance

Magnetic systems attract Ferromagnetic particles. Regular cleaning is essential. A clean magnet functions considerably better

All parts are best cleaned with pressurized air and/or a soft cloth. It's also possible to deep clean with special cleaning fluids that do not harm the material. Ensure that these fluids do not contaminate the product

Regularly check that all warning pictograms and the identification plate are present at the correct locations on the device. If warning pictograms or the identification plate should get lost or damaged, immediately apply new ones to the original locations.

Always inform operating personnel regarding planned inspections, maintenance, repairs or if attending to breakdowns.

Magnet bars

The low speed of the magnet bars and the relatively small amount of movements will cause only little wear to the inner bars. *Normal wear can however always occur.*

- Depending on the product (abrasive or not) and the Fe contamination the magnet bar tubes can wear out.

Wear as a following of abrasive product can be reduced by coating the outside bars, with for instance tungsten carbide.

Please contact **GOUDSMIT magnetic systems BV** for advise.

- After some time the pneumatic components inside the bars can wear out, so they need to be replaced. The time interval for this is depending on the cleaning cycle, the product, etc. An indication for revision is the air supply to the magnet. **When more than 8 bar is needed to move the magnet bars, then the bar(s) need to be repaired/revise**d = replacing the pneumatic components and clean the inside magnet bar.

Error! Use the Home tab to apply Kop 1 to the text that you want to appear here.

Magnet bar tubes

The magnet bar tubes have a very small wall thickness. This creates a great Fe separation result. Heavy parts (Fe or product) however, may hit the bar in a way that bumps occur, as this will block the movement of the magnet bar.

Make sure that no heavy parts in your product flow can damage the magnet bar tubes!
We advise to place a (mechanical) sieve (filter) in front of the SECC.

Damage, caused by damaged magnet bar tube(s), cannot be claimed by warranty.



When a bar is damaged it has to be replaced by another (spare) one immediately to prevent further damage to the bar and or cleanflow. The damaged bar can be sent to **Goudsmit Magnetic Systems** for repair/revision.

Exchange / revise magnet bars

- **Magnet bar dismantling:** take away the protection plate at the head side of the device. Then dismantle the aluminium end flange of the magnet bar. After that the pneumatic coupling at the other side of the housing needs to be dismantled. At last, after taking away the side screen, grab the bar and pull it out at one of the 3 thicker SS bushes of the bar.
- **! Do not dismantle the magnet bar itself** ☐ **magnetic danger!**
- **“Hutmanchet” dismantling:** the Hutmanchets are screwed against the middle plates of the housing. They can be screwed loose via the screen opening after having dismantled the magnet bars.

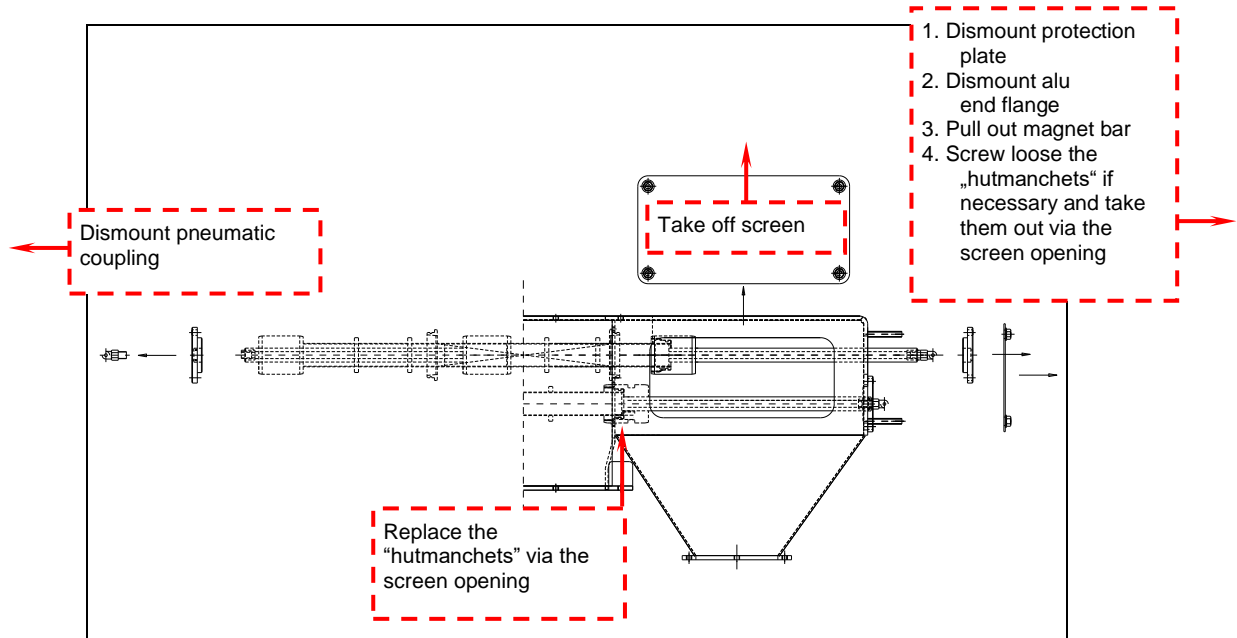

Drawing: SECC magnet bar and “hutmanchet” dismantling

Cleaning & ATEX

To prevent explosion risk, avoid dust clouds and the build-up of dust layers. If dust particles or layers heat up they may ignite and burn. This in turn can ignite airborne dust cloud cause an explosion.

Error! Use the Home tab to apply Kop 1 to the text that you want to appear here.

Malfunctions/Service

	CAUTION!
	<p>Improper handling of the magnet device may lead to damages. Potential damage to body and property!</p> <ul style="list-style-type: none"> • Any repair to GOUDSMIT magnet devices may be performed by qualified personnel only. • Be aware that permanent magnetic material attracts ferromagnetic material with great force when it gets in reach of the magnetic field • Consult GOUDSMIT MAGNETIC SYSTEMS customer service.

Malfunctions

In case of malfunctions, consult the following table in order to determine the cause of the malfunction and its possible remedy. In case a specific malfunction can't be found in the table, consult the GOUDSMIT Magnetic Systems customer service.

Failure / breakdown	Possible cause	Possible solution
Magnet does not separate ferromagnetic (Fe) parts, or separates them badly	Magnet bar is overloaded with Fe parts	Clean the magnet more frequently (adjust cleaning cycle time parameters)
	Not-attracted objects are not magnetic	Check if particles to be separated are magnetic, using a permanent magnet
	Ferromagnetic parts close to the magnet reduces the magnetic field	Check if there is ferromagnetic material close to the bar. If so, replace the ferromagnetic material by non-ferromagnetic material
Magnet bar tube is not moving any more or moves badly	Air pressure is (too) low	Set to higher air pressure (max 8 bar)
	Air connection(s) is(are) not connected any more	Fix air connection(s)
	Tube is dented	Take bar out and replace it. (Let damaged bar be revised if possible)
	Too much Fe material on tube(s)	Set to higher air pressure for one time solution and in future clean more often
	Pneumatic components in the extractor tube are leaking and need to be replaced	Take the magnet bar out and replace it. Send old bar back for repair/revision to GOUDSMIT Magnetic Systems

Customer service

Please have the following information available if you require customer service assistance:

- Identification plate (complete)
- Type and extent of the problem
- Time the problem occurred and any accompanying circumstances
- Assumed cause

Error! Use the Home tab to apply Kop 1 to the text that you want to appear here.

Spare parts

As a result of the robustness and quality of **GOUDSMIT magnetic systems** products the device possesses high operational reliability.

When however a specific component requires replacement, the correct component can be ordered by quoting the type number stated on the *identification plate* or on one of the drawing(s) added to this user manual in the added data sheet.

The spare parts are mostly wear parts, such as:
magnet bars, pneumatic parts inside the magnet bars, the slide bushes or “hutmanchets” between rotor and magnet bars and the sealings (option) inside these bushes

We advise to have 1 or more magnet bars in stock as a spare part:
see added drawings for article numbers.

- We advise to have 1 or more complete magnet bars in stock as a spare part *and have the magnet bars revised/repared by Goudsmit because of their magnet expertise (jamming danger etc.)!*

Following mutual consultation Goudsmit magnetic systems will arrange rapid and correct delivery.

Error! Use the Home tab to apply Kop 1 to the text that you want to appear here.

Storage and Dismantling

Storage

If the device will not be used for a long period of time, we advise to store the device in a dry, safe place and to conserve fragile and/or sensitive parts.

Dismantling / scrapping

On scrapping and/or disposal of the device's parts separately, take into account the different nature and dangers of the components (magnets, iron, aluminium, electrical parts, insulating materials, etc.) and ensure safe disposal. Preferably entrust the task to a specialised company, and always observe the local regulations in regard to disposal of industrial waste.