

## Accessories

### Electrical switch contacts

- Model 821, magnetic snap-action contact
- Model 831, inductive contact
- Model 830 E, electronic contact
- Model 851, reed contact

WIK A data sheet AC 08.01

#### Applications

- Control and regulation of industrial processes
- Monitoring of plant and switching of electric circuits
- Indication of limit conditions
- Inductive contact for completely fail-safe switching, even in explosion hazardous areas
- Process industry applications in machine and plant construction, chemical and petrochemical industry, power plants, mining, onshore and offshore and environmental engineering

#### Special features

- High reliability and long service life
- Can be incorporated within all relevant pressure and temperature measuring instruments
- Up to 4 switching contacts per instrument
- Also available with liquid-filled case for high dynamic pressure loads and vibration
- Inductive contact, also available in safety pattern and electronic contact for PLCs

#### Description

Switch contacts (electrical alarm contacts) make or break an electric control circuit dependent upon the position of the instrument pointer. The switch contacts are adjustable over the full extent of the scale range (see DIN 16085), and are mounted predominantly below the dial, though also partly on top of the dial.

The instrument pointer (actual value pointer) moves freely across the entire scale range, independent of the setting. Both circular gauges and square panel-mounted gauges feature an adjustment key in the centre of the window. Contacts in flush panel-mounted gauges are adjustable using a screwdriver through the window. Several switch contacts can also be set to at the same setpoint. Contact actuation is made when the actual value pointer travels beyond or below the desired set value.



Pressure gauge model 212.20.100 with model 821 switch contact



Thermometer model 55 with model 831 inductive contact

#### Options

##### Gauges with special approvals on inquiry, e.g.

- Pressure switches with DVGW approval (DIN 3398/EN 1854)
- Pressure and temperature measuring instruments with alarm contacts for intrinsically safe electrical systems
- Pressure gauges for connection to dust-Ex areas zone 21/22 or to gas-Ex zone 0.

WIK A datasheet AC08.01 - 02/2017

Page 1 of 24

Data Sheets showing similar devices:  
Transmitter to combine with pressure gauges; see data sheet AC08.02



### Model 821 magnetic snap-action contacts <sup>1)</sup>

#### Application

This contact can be used in a whole range of operating conditions, including with liquid-filled instruments. The set pointer has an adjustable permanent magnet attached, giving a snap-action characteristic which strengthens the contact force. This snap-action behaviour provides further protection of the contacts against harmful arcing effects, though it increases the hysteresis from 2 % to 5 % of the measuring range. The hysteresis is the difference in indicated value measured from opposing directions of travel with the switch point unaltered. The signal is made either before or after mating, dependent upon the movement of the instrument pointer.

- 1) Particularly for temperature measurement, where bimetal measuring systems only have very low actuating power and if the operating conditions are such that there is no vibration, the **model 811 sliding contacts** should be used. This type of contact is not suitable for liquid-filled instruments.

#### Specifications and contact ratings table

Observing the data supplied will ensure many years of problem-free operation for the switch contacts. For higher loads (max. 1840 VA), and also for liquid-filled gauges, we recommend our model 905.1X contact protection relays (page 9).

In accordance with DIN 16085, requirements on pressure measuring instruments with contacts for switching currents less than 24 V should be agreed specifically between the user and manufacturer.

#### Attention!

**For low ratings, to maintain reliability, the current to be switched should not be less than 20 mA. In order to ensure more reliable contact switching, taking environmental influences over the long term into account as well, the switching voltage should not be below 24 V.**

For switching inductive or capacitive loads, you should take the usual measures for protecting contacts from erosion. For Programmable Logic Controllers (PLC) we recommend our model 830 E electronic contacts (see page 14 onwards).

### Specifications

Maximum contact rating with resistive load	Magnetic snap-action contact, model 821		Sliding contact, model 811
	dry gauges	liquid-filled gauges	dry gauges
Maximum voltage (MSR) $U_{eff}$	250 V	250 V	250 V
Current ratings: <sup>1)</sup>			
- Make rating	1.0 A	1.0 A	0.7 A
- Break rating	1.0 A	1.0 A	0.7 A
- Continuous load	0.6 A	0.6 A	0.6 A
Maximum load	30 W / 50 VA	20 W / 20 VA	10 W / 18 VA
Material of contact points	Silver-Nickel Alloy (80 % Ag / 20 % Ni / gold-plated)		
Ambient operating temperature	-20 ... +70 °C		
Max. no. of contacts	4		

<sup>1)</sup> The values given for nominal working currents apply to instrument designs with Switch Version S. For Version L, these values should be halved. (See table on page 3 for appropriate version)

### Recommended contact ratings with resistive and inductive loads

Voltage (DIN IEC 38) DC / AC	Magnetic snap-action contact, model 821						Sliding contact, model 811		
	dry gauges			liquid filled gauges			dry gauges		
	resistive load		inductive load	resistive load		inductive load	resistive load		inductive load
	DC	AC	$\cos \phi > 0.7$	DC	AC	$\cos \phi > 0.7$	DC	AC	$\cos \phi > 0.7$
V	mA	mA	mA	mA	mA	mA	mA	mA	mA
220 / 230	100	120	65	65	90	40	40	45	25
110 / 110	200	240	130	130	180	85	80	90	45
48 / 48	300	450	200	190	330	130	120	170	70
24 / 24	400	600	250	250	450	150	200	250	100

## Contact point materials

Depending upon the switching conditions, the switch contacts are subjected to greater or lesser erosion due to the effects of the unavoidable arcing and through mechanical wear. As a result, when selecting the contact material, attention should be paid to the predominant operating conditions. The following contact materials are available:

### Silver-nickel alloy

(80 % silver / 20 % nickel / gold-plated)

Material properties:

- Excellent hardness and strength.
- Good resistance against arcing.
- Low inclination to fuse together.
- Low contact resistance.

Due to its good balance of properties and wide application possibilities, this alloy is used as our standard material.

### Platinum-iridium alloy

(75 % platinum, 25 % iridium)

This alloy has outstanding chemical resistance, as well as being hard and very resistant to arc formation. It is used for high switching frequencies, high switching currents and in aggressive environments.

## Special designs

- Contacts with separate circuits
- Changeover contacts (open and closed simultaneously for the same setpoint)
- Switch point fixed
- Linked contacts
- Contacts with 47 kΩ "live zero" shunt to monitor circuit continuity
- Self-cleaning contacts (NS 160 only)
- Contact setting lock with lead sealing
- Non-detachable contact setting key
- Plug connection (instead of junction box or flying lead)
- Contact points of special platinum-iridium alloy

## Switch version appropriate to gauge model and range

(in order to define limits, please refer to the table at the top of page 2 and footnote)

WIKA basic gauge model	Nominal size	Number of contacts in instrument	Measuring ranges	Switch version
2xx.xx	100 and 160	1	≤ 1 bar	L
2xx.xx	100 and 160	1	all others	S
2xx.xx	100 and 160	2	≤ 1.6 bar	L
2xx.xx	100 and 160	2	all others	S
2xx.xx	100	3 or 4	≤ 4 bar	L
2xx.xx	100	3 or 4	all others	S
2xx.xx	160	3 or 4	≤ 2.5 bar	L
2xx.xx	160	3 or 4	all others	S
214.11	96 x 96 and 144 x 144	1	≤ 1 bar	L
214.11	96 x 96 and 144 x 144	1	all others	S
214.11	96 x 96 and 144 x 144	2	≤ 1.6 bar	L
214.11	96 x 96 and 144 x 144	2	all others	S
214.11	96 x 96	3	≤ 4 bar	L
214.11	96 x 96	3	all others	S
214.11	144 x 144	3	≤ 2.5 bar	L
214.11	144 x 144	3	all others	S
3xx.xx	160	1 ... 4	all	L
4xx.xx	100 and 160	1 ... 4	all	L
5xx.xx	100 and 160	1 ... 4	all	L
6xx.xx	100 and 160	1 or 2	≥ 100 mbar	L
7xx.xx	100 and 160	1 ... 4	all	L
55	100 and 160	1 ... 4	all	L
73	100 and 160	1 ... 4	all	L
74	100	1 ... 4	all	L
76	100 and 160	1 ... 4	all	L

## Switch functions

For the switch functions for model 821 magnetic snap-action contacts and model 811 sliding contacts the following generally applies for our default settings:

















- Index 1** Contact makes when the instrument pointer approaches the set point in a clockwise direction. (NO contact)
- Index 2** Contact breaks when the instrument pointer approaches the set point in a clockwise direction. (NC contact)
- Index 3** Contact first breaks and then makes a second circuit when the instrument pointer approaches the set point in clockwise direction. (SPDT contact)

For switch contacts with several contacts, the 1<sup>st</sup> contact is the one which is closest to the left-hand beginning of the scale, or end value (for vacuum gauges).

The switch function, described in the following table, follows the clockwise rotary motion of the instrument pointer (actual value pointer).

If the actual value pointer moves anticlockwise, the reverse switch function occurs!

**Note:** If the switch contacts are to be set (adjusted) anticlockwise, the index figures in brackets must be used in accordance with DIN 16085. Combinations are possible.

Single contact <sup>1)</sup>			
Wiring scheme	Clockwise pointer motion Contact function		Model code and function index for magnetic snap-action contacts or sliding contacts (special version)
	Contact makes when pointer reaches set point (NO - normally open)		821.1 and 811.1 (.5)
	Contact breaks when pointer reaches set point (NC - normally closed)		821.2 and 811.2 (.4)
	SPDT: 1 contact breaks and 1 contact makes when pointer reaches set point (change over)		821.3 and 811.3 (.6)
Double contact <sup>1)</sup>			
	1st and 2nd contact make when pointer reaches set point		821.11 and 811.11 (.55)
	1st contact makes 2nd contact breaks when pointer reaches set point		821.12 and 811.12 (.54)
	1st contact breaks 2nd contact makes when pointer reaches set point		821.21 and 811.21 (.45)
	1st and 2nd contact break when pointer reaches set point		821.22 and 811.22 (.44)
Triple contact <sup>1)</sup>			
	1st contact breaks 2nd contact makes 3rd contact breaks when pointer reaches set point		821.212 and 811.212 (.454)

<sup>1)</sup> When ordering, please include the appropriate function index with the contact model number (follow the sequence of 1st, 2nd 3rd contact), see example 821.212.

The connecting terminals and/or connecting wires are specified according to the table above. Protective earth each yellow-green. Configurations which are possible are found on pages 20/21.

## Model 851 reed contact

### Application

Reed contacts are frequently used for switching small voltages and currents, since, due to their hermetically-sealed construction alongside contacts operating in inert gas, the contact surfaces cannot corrode.

Through their high reliability and their low contact resistance, they are suitable for many applications. These are, for example, PLC applications, signal switching in measuring instruments, indicator lights, audible alarms and many more. Due to the contacts being in a hermetically-sealed enclosure, they are most suited where they will be used at high altitude. Since the thinner the atmosphere, the greater the contact clearance needs to be to prevent arcing.

Reed contacts need no electrical power supply and, due to their low mass, are insensitive to vibration. With 2 contacts, the individual switches are galvanically isolated from each other.

### Note

On the basis of their ability both with low currents and voltage and, at the same time, switching loads up to 60 Watt, these contacts are ideal for use in applications in the planning phase where it is not yet 100 % defined how the signals will be processed.

### Operating principle

One reed contact consists of three contact blades (changeover, SPDT) from a ferromagnetic material, which are fused into an inert gas atmosphere within a glass envelope. In order to reduce abrasive wear and to ensure a low contact resistance, the blades are metal coated in the area of the contact surface. The reed contact is operated through an external magnetic field (such as a permanent magnet) with sufficient field strength. The switching state will remain until the magnetic field strength has fallen below a certain value. WIKA generally uses bistable and magnetically biased reed contacts. Through the bias, the signal state remains until a magnetic field with an opposite magnetic polarity to the contact resets it.

### Example:

If the switch point on a 10 bar switchGAUGE is set, for example, to 1 bar and the instrument pointer with magnet sweeps past this value in a positive direction, the reed switch contact will maintain its state even if the pointer continues to 10 bar, for example.

The reed contact will only change its state again when the pointer passes through 1 bar in the direction of 0 bar.

With its hard coating on the contact surface with, for example, ferromagnetic rhodium, the reed contact achieves a very long life. The number of possible operations of a reed contact depends largely on the magnitude of the electrical load; but is empirically in the range of  $10^6$  to  $10^7$ .

If only signal loads or no loads are connected, then operations of a magnitude above  $10^8$  are easily achievable. With switching voltages below 5 V (arcing limit), operations over  $10^9$  are also achievable. With capacitive or inductive loads, the use of a suppressor is needed since the current or voltage spikes that occur with these can destroy the reed contact, or, at the least, significantly reduce its lifespan. For this, see the section on contact protection measures on page 7.

If a magnetic field approaches the reed switch, both contact blades are pulled together and the contact closes. The electrical current can flow.

If the magnetic field is moved further away, the field strength will decrease with increasing distance. The contact, through its bistability, remains closed. Only by a magnetic field re-approaching the reed contact in the opposite direction will the two contact blades open again. The electric current is interrupted.

Like other mechanical switches, the reed contact is not free from bounce. The bounce times with them are, however, shorter than in most other mechanical contacts. Nevertheless, this physical property, found mainly in PLC applications, attracts attention (keyword: software debounce/pushbutton debounce).

### Functional diagram

Reed contact SPDT (changeover) not actuated

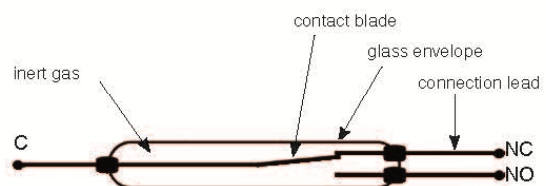

C = common  
NC = normally closed  
NO = normally open

Reed contact SPDT (changeover) actuated

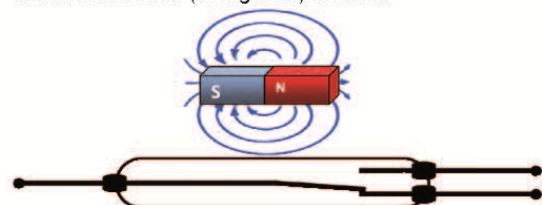

### Model 851 reed contact specifications

This contact can be built into the following models:

#### Pressure measurement:

- 712.15
- 732.15
- PGS23.100
- PGS23.160
- PGS63HP.100
- PGS63HP.160
- PGS43.100
- PGS43.160
- PGS43HP.100
- PGS43HP.160
- DPGS43.100
- DPGS43.160
- DPGS43HP.100
- DPGS43HP.160
- APGS43.100
- APGS43.160

#### Temperature measurement:

- 73
- 74

Maximum contact rating with resistive load		
Contact design		Changeover
Contact type		bistable
Max. switching voltage	AC/DC V	250
Min. switching voltage	V	N/A
Switching current	AC/DC A	1
Min. switching current	mA	N/A
Carry current	AC/DC A	2
cos φ		1
Switching capacity	W/VA	60
Contact resistance (static)	mΩ	100
Insulation resistance	Ω	10 <sup>9</sup>
Breakdown voltage	DC V	1000
Operate time incl. bounce	ms	4.5
Contact material		Rhodium
Switching hysteresis	%	3 ... 5

- The limit values listed here should not, independently of each other, be exceeded.
- If two contacts are used, they cannot be set to the same value. A minimum distance of approx. 30° is required.
- The adjustment range of the contacts is 10 ... 90 % of the scale.
- The switching hysteresis can be set during production so that the reed contact will be actuated exactly at the desired switch point. For this we need the switching direction to be specified in the order.
- Further reed contacts are applied in the model 700.0x and model 230.15 2" pressure gauges. for further specifications see the applicable data sheets.

### Causes of overload for magnetic snap-action or reed contacts

#### General

Each mechanical switch has 4 physical limits. These are:

- Maximum electrical switching voltage
- Maximum electrical switching current
- Maximum electrical power to be switched
- Maximum mechanical switching rate

The switch must not be operated outside of these physical limits. The operating life of the switch will be reduced even if only one of these limits is exceeded during operation. The further one or more of these limits is exceeded, the greater the reduction in the operating life of the contact; even to the point of immediate failure.

### Causes of electrical overload

#### Maximum electrical switching voltage

When an electrical load is switched, to a greater or lesser degree, an electrical arc can be seen between the contact points. The very high local heating caused by this leads to the gradual evaporation of the contact material with each switching operation (material erosion, burn-off). The higher the voltage that is switched, the greater the arc that is produced and thus the faster the contact material evaporates.

Long-term damage occurs to the contacts.

#### Maximum electrical switching current

When an electrical current is switched, the contact surfaces are heated by the electron flow (contact resistance). If the maximum permissible switching current is exceeded, the contacts will stick to each other. This can lead to the contact points welding or sticking.

Long-term damage occurs to the contacts.

#### Maximum electrical power

The maximum electrical power that a contact can switch is the product of the switching voltage and the switching current. This electrical power heats the contacts and the limit must not be exceeded (welding, sticking).

Long-term damage occurs to the contacts.

#### Maximum mechanical switching rate

The maximum mechanical switching frequency possible depends upon both the wear of the bearings and material fatigue.

#### Minimum electrical values

Each mechanical contact also possesses a threshold resistance resulting from surface contamination (surface contamination resistance  $R_F$ ).

This surface contamination resistance results from the oxidation or corrosion of the contact surfaces and increases the electrical resistance of the switch.

When switching at low power, this layer will not be penetrated.

Only by switching with higher currents and voltages will this be destroyed. This effect is known as fritting, and the minimum voltage needed for it is the fritting voltage.

If this voltage is not reached with switching, the contamination layer resistance will continue to grow and the switch will cease to work.

This effect is reversible.

#### Further information

Such an electrical overload can be caused by the following (e.g.):

- Light bulbs draw 15 times as much current at the moment of switching than they do in normal operation (nominal value).
- Capacitive loads form a short-circuit at the moment of switching (long control cables, cables running in parallel).
- Inductive components (relays, contactors, solenoid valves, wound cable drums, electric motors) create very high voltages when switching (up to 10 times the nominal voltage).

### Measures to protect the contacts

Mechanical contacts must not exceed their specified electrical limits for switching current and voltage, even for a short time.

For capacitive or inductive loads we recommend one of the following protective circuits:

#### 1. Inductive load for DC voltage

With DC, the contact protection can be achieved via a freewheeling diode, connected in parallel to the load. The polarity of the diode must be arranged so that it closes when the operating voltage is on.

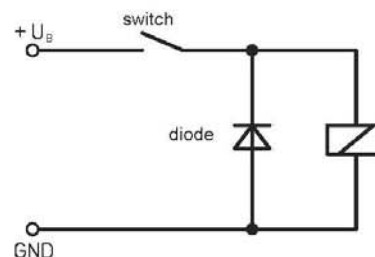

Example: protecting the contacts with a freewheeling diode

**2. Inductive load with AC**

There are two protection possibilities with AC voltage.

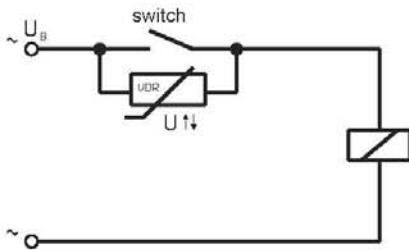

Example: Contact protection via a voltage dependent resistance (VDR)

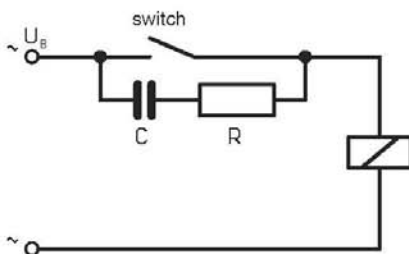

Example: Contact protection via an RC-circuit

**3. Capacitive loading**

With capacitive loads, elevated switch-on currents arise. These can be reduced while connecting a series resistor in the switching circuit.

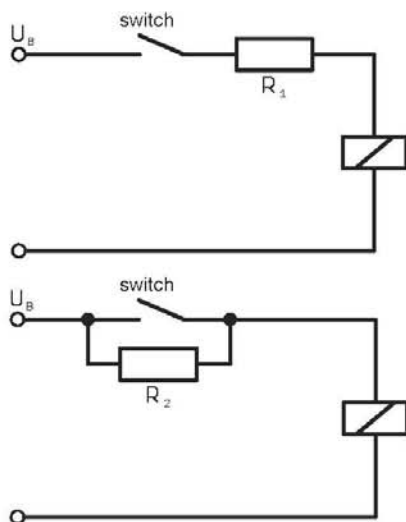

Example: Contact protection via a current-limiting resistance

**Contact curve**

The hatched area of the contact curve shows the permissible electrical values for the respective contact. The voltage to be switched must neither be over the maximum, nor below the minimum switching voltage ( $V_{max} \leq U_s \leq V_{min}$ ). The current to be switched must neither be over the maximum, nor below the minimum switching current ( $A_{max} \leq I_s \leq A_{min}$ ). The power to be switched should only lie below the limit curve.

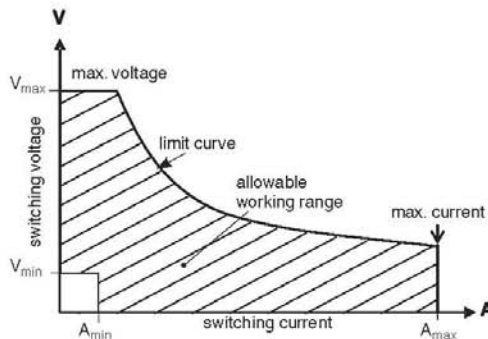



### Contact protection

Contact protection relays are used with model 821 and 811 contact relays if the permissible contact rating of the switch contacts is not sufficient.

The contact protection relays are triggered by the switch contacts and switch the load.

On the contact side, they operate with a low control voltage, however, on their output side they have a high power rating.

Contact protection relays consist of a power unit, a control unit, a switching amplifier and a relay output.

The contacts are supplied from the control unit with a clocked DC voltage of between 35 to 40 V (meaning that only every hundredth or so switching occurs under voltage).

In this way, optimal contact protection switching safety is achieved for several million switch cycles.

Liquid-filled gauges with contacts, which switch frequently, should generally be used in conjunction with contact protection relays. The filling increases the service life of the mechanical measuring systems, but at the same time it increases the erosion of the contact points.

As well as the outputs to operate the contacts, an additional 24 V output with (max. 20 mA) is available. This can drive, for example, indicator lights or transmitters.

In order to avoid unintended switching, through (for example) vibration, the switch signal must be present for a minimum of 0.5 seconds before the output from the contact relay switches (switch-off delay).

### Overview of models

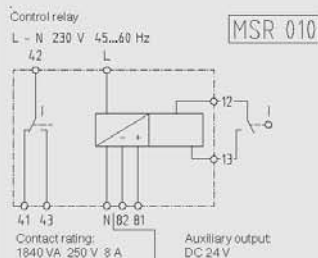
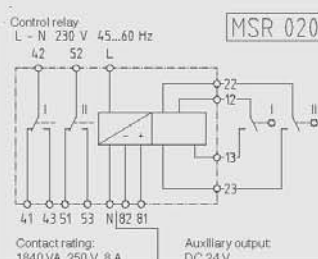
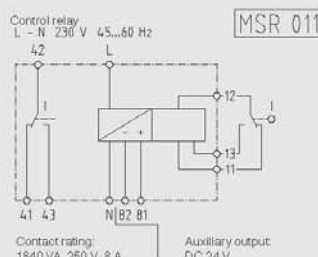
Model	For connection to instruments	Function / output	
905.12 MSR 010	with 1 contact	1 double throw contact	 <p>Control relay L - N 230 V 45...60 Hz</p> <p>42 L</p> <p>41 43 N B2 B1</p> <p>12 13</p> <p>Contact rating: 1840 VA 250 V 8 A</p> <p>Auxiliary output: DC 24 V</p> <p>1036698</p>
905.13 MSR 020	with 2 contacts	2 double throw contacts	 <p>Control relay L - N 230 V 45...60 Hz</p> <p>42 52 L</p> <p>41 43 51 53 N B2 B1</p> <p>22 12 13 23</p> <p>Contact rating: 1840 VA 250 V 8 A</p> <p>Auxiliary output: DC 24 V</p> <p>1036696</p>
905.14 MSR 011	with 2 contacts (Function 21 must be specified)	1 double throw with flip-flop characteristic (interval switch for control- ling pumps)	 <p>Control relay L - N 230 V 45...60 Hz</p> <p>42 L</p> <p>41 43 N B2 B1</p> <p>12 13 11</p> <p>Contact rating: 1840 VA 250 V 8 A</p> <p>Auxiliary output: DC 24 V</p> <p>1036700</p>

Specifications	Control relays model 905.12 ... 14
Line voltage	AC 230 V -10 % / +6 %, 45 ... 60 Hz
Power consumption	ca. 2.5 VA
Pulsating current voltage	35 to 40 V; Isolated transformer
Pulse rate	1 : 100 typically
Pulse width	250 µs typically
Relay time lag	ca. 0.5 s
Relay output	potential-free, mono or bistable double throw contact (see review of available models)
■ Contact rating	AC 250 V, 8 A, 1840 VA
Auxiliary output	DC 24 V
■ Current rating	20 mA
Wiring identification	DIN 45410
Protection	Insulated system
Insulation class	C/250 V per VDE 0110
Enclosure size	Form C, page 15
Enclosure material	Polyamide 6.6, green
Ingress protection	Case IP40, Terminals IP20 (per EN 60529 / IEC 60529)
Operating temperature	0 ... 70 °C
Mounting	Snap-mounting on DIN 50022 rail 35 x 7.5 mm (Surface mounting adaptor included)

Connection examples for control relays

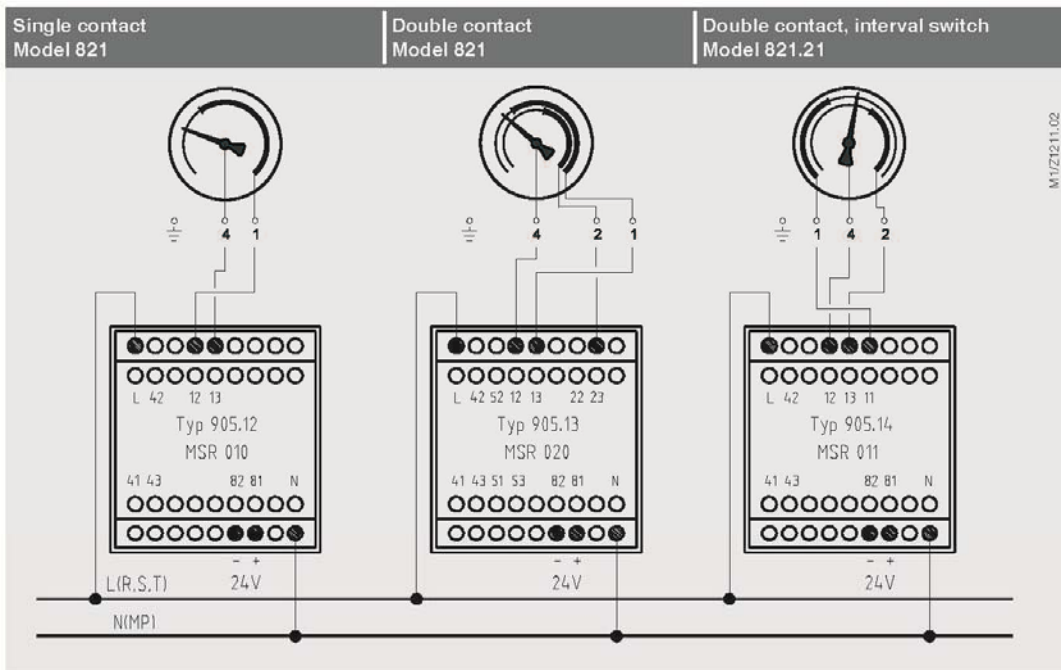

### Inductive contact model 831

#### Application

Measuring instruments with WIKA inductive contacts may be operated in Zone 1 and 2 explosion hazardous areas, provided that they are powered from a suitable and certified control circuit (e.g. WIKA model 904.28 control unit). Outside of Ex areas, WIKA inductive contacts are primarily used where particularly safe switching at higher switching rates is important. Since these contacts also work in liquid filling, such instruments are themselves usable in very particular operating conditions. Some typical application areas are those in chemical, petrochemical and nuclear plants.

#### Operating principle

The WIKA inductive contact works in a non-contact way. Essentially it consists of the control head (initiator), attached to the set pointer, with its fully-potted electronics and the mechanical assembly with the moving flag. The flag is moved by the instrument pointer (actual value pointer). The control head is supplied with a DC voltage. When the flag enters the slot in the control head this then increases its internal resistance (= damped condition/initiator has high-impedance). The subsequent change in the current acts as the input signal for the switching amplifier of the control unit.

#### Functional diagram

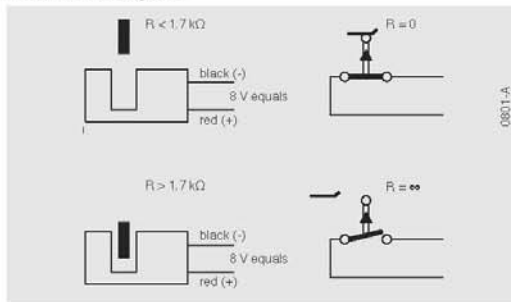

The control unit works, practically, without any reaction on the measuring system. The non-contact "contact system" produces no wear within the electrical system. The installed dimensions correspond to those of the model 821 contacts. The setting of the setpoints is made in the same way as for those contacts.

Ambient temperature: -25 ... +70 °C 1)

Sensor used (slot-type initiator): Pepperl and Fuchs Type SJ, EC Type-test Certificate PTB 99 ATEX 2219 X and ZELM 03 ATEX 0128 X

1) For use in hazardous areas, the upper limits for the ambient temperature mentioned in the test certificate must be complied with! These depend on voltage, current rating, power consumption and temperature class.

#### Advantages of the WIKA inductive system

- Long service life due to non-contact sensor
- Low reaction to on the display
- All-purpose, also with liquid filled gauges
- Fully suitable for corrosive or hazardous atmospheres (potted electronics, non-contact switches)
- Ex-approved for service in Zone 1 or 2 hazardous areas (intrinsic safety)

#### Components of the WIKA inductive contact system

The WIKA inductive contact system includes the WIKA inductive contacts, built into the instrument, (already described) and the WIKA control unit (see page 15 onwards).

#### The WIKA control unit consists of

- Line transformer
- Switching amplifier
- Output relay

The line transformer converts the AC supply voltage to a DC voltage. The switching amplifier drives the control head and switches the output relay. Via the output relay, higher electrical loads can be switched.

#### Two versions of the control units are available

- Ex-approved **intrinsic safety**
- Standard for **non intrinsically safe** version

The intrinsically safe version meets to EN 50014 / EN 50020 and is type-tested. With these, inductive contacts can be used in Zone 1 or Zone 2 hazardous areas.

**Note:** The control unit itself must be installed outside the hazardous area.

The switching characteristic of the control unit can be set via wire jumpers and/or sliding switches. This enables the action of the switching function to be reversed, e.g. the flag can cause the sensor

- output relay to be either energised or de-energised.

In addition, it is possible to configure line break monitoring.

With **non intrinsically safe control units**, inductive contacts must not be operated in explosion hazardous areas. Their direction of action is permanently fixed. The output relay is de-energised when the flag passes through the air gap. The line break monitoring is in series. Apart from the outputs required for the operation of the switch contacts, there is an additional output with a direct 24 V voltage (max. 20 mA). This additional output can be used, for example, to supply the indicator lights.

### Contact function index

For the switch functions for model 831 inductive contacts the following generally applies for our default settings:

**Index 1** Inductive contact makes when the instrument pointer approaches the set point in a clockwise direction. (Flag leaves control head)



















**Index 2** Inductive contact breaks when the instrument pointer approaches the set point in a clockwise direction. (Flag enters control head)

For inductive contacts with several contacts, the 1<sup>st</sup> contact is the one which is closest to the left-hand beginning of the scale, or end value (for vacuum gauges).

The switch function, described in the following table, follows the clockwise rotary motion of the instrument pointer (actual value pointer).

If the actual value pointer moves anticlockwise, the reverse switch function occurs!

**Note:** If the inductive contacts are to be set (adjusted) anticlockwise, the index figures in brackets must be used in accordance with DIN 16085. Combinations are possible.

Single contacts <sup>1)</sup>					
Wiring scheme <sup>2)</sup>	With clockwise pointer motion, when pointer reaches set point, the flag	Contact function (principle)			Model code and function index of inductive contacts
	Leaves the sensor	Contact makes (NO-normally open)			<b>831.1</b> (.5)
	Enters the sensor	Contact breaks (NC-normally closed)			<b>831.2</b> (.4)
Double contacts <sup>1)</sup>					
	Leaves 1st and 2nd	1st and 2nd contact make			<b>831.11</b> (.55)
	1st leaves, 2nd enters	1st contact makes, 2nd contact breaks			<b>831.12</b> (.54)
	1st enters, 2nd leaves	1st contact breaks, 2nd contact makes			<b>831.21</b> (.45)
	1st and 2nd enters the sensor	1st and 2nd contact breaks			<b>831.22</b> (.44)
Triple contacts <sup>1)</sup>					
A number of instruments will also accept triple inductive contacts (see page 20/21). Technical notes page 13 Wiring schemes and possible characteristics are the same as above.					

1) When ordering, please include the appropriate function index with the inductive contact model number (follow the sequence of 1<sup>st</sup>, 2<sup>nd</sup> 3<sup>rd</sup> contact).

2) Thin line: Flag enters control head, circuit open.  
Bold line: Flag leaves control head, circuit closed.

Wiring terminals are identified according to the above wiring schemes.  
Configurations possible for individual instruments are found on pages 20/21

### Triple inductive contact

With triple inductive contacts it is not possible to set all three contacts overlapping at the same scale value. Either the left (= no. 1 contact) or the right contact (= no. 3 contact) must be at an approximate separation of  $\geq 30^\circ$  to the left or the right of the other two contacts, which may be set to the same value:

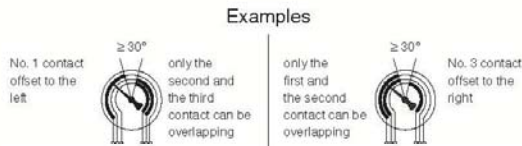

### All possible configurations of triple inductive contacts:

1st contact not overlapping	3rd contact not overlapping
Model	Model
831.1.11	831.11.1
831.1.12	831.11.2
831.1.21	831.12.1
831.1.22	831.12.2
831.2.11	831.21.1
831.2.12	831.21.2
831.2.21	831.22.1
831.2.22	831.22.2

## Inductive contacts - special designs

### ■ Fail-safe inductive contacts models 831 SN and 831 S1N

For particularly important, safety-relevant applications, such as for fitting to self-monitoring controls, type-tested components must be used. The model 831 SN and 831 S1N fail-safe inductive contacts have the appropriate certificates. It is a requirement that they must be used in conjunction with a similarly certified, fail-safe control unit (switching amplifier), e.g. model 904.30 KHA6-SH-Ex 1 (see page 16).

Measuring instruments with fail-safe inductive contacts may be operated within Zone 1 explosion hazardous areas.

Control unit used (SN/S1N slot-type initiator): Pepperl Fuchs Type SJ, EC-Type-test Certificate PTB 00 ATEX 2049 X and ZELM 03 ATEX 0128 X

### Switching characteristics, model 831 SN

When the flag is positioned within the slot initiator, the output of the series-connected control unit (0-signal) is **blocked**, i.e. the output relay is **released** (= alarm condition).

Contact function indices, flag behaviour and wiring schemes are identical to inductive contacts model 831 (see page 12).

### Switching characteristics, model 831 S1N

When the flag is positioned **outside** of the slot initiator, the output of the series-connected control unit (0-signal) is **blocked**, i.e. the output relay is **released** (= alarm condition).

Contact function index scheme is the same as that for inductive contacts model 831 SN with the following differences:

**Index 1** (following the contact model no.) means inductive **contact makes** when set point is reached in a clockwise direction (flag enters control head).

**Index 2** (following the contact model no.) means inductive **contact breaks** when set point is reached in a clockwise direction (flag leaves control head).

Possible configurations as shown in the tables on pages 20/21.

### ■ Triple inductive contact NS 160, one set point for all three contacts

If it is absolutely necessary to set all three contacts to the same value, this can be achieved with the NS 160 design using smaller control heads. Please specify when ordering.

### ■ Quadruple contacts

The panel-mounting pressure gauges NS 144 x 72 can accept up to 4 inductive contacts (see page 20).

## Electronic contact model 830 E

### Description, Application

Direct switching of small loads, which are usually required for a PLC, can be realised by this inductive contact with integrated amplifier, which is factory-installed into the measuring instrument.

The usual advantages of inductive contacts, such as fail-safe contact operation, no wear due to proximity contact operation as well as virtually no effect on the measuring system, thus ensuring the accuracy of the indication, also apply here.

### An additional control unit is not required.

The electronic contact with PNP output can be specified in either a 2- or 3-wire design.  
The operating voltage is DC 10 ... 30 V. The maximum switching current is 100 mA.

The model 830 E electronic contact is **not intrinsically safe** and therefore not suitable for applications where explosion protection is required.

See page 15 for further technical data.

The contact function index is the same as that for the model 831 inductive contact with the following differences:

**Index 1** (following the inductive contact model no.) means the **contact makes** when the set point is reached in a clockwise direction (**flag enters control head**)

**Index 2** (following the inductive contact model no.) means the **contact breaks** when the set point is reached in a clockwise direction (**flag leaves control head**)

**Note:** This operation is directly opposite to that of model 831!

### Wiring details

The control and switching electronics are in the sensor, the electrical connection is via a terminal box.

- To connect to a PLC or for the direct switching of small loads
- PNP transistor  
With PNP switching apparatus, the switched output is connected to PLUS. The load  $R_L$  between the switched output and the MINUS should be specified so that the maximum switching current (100 mA) is not exceeded.
- Flag leaves slot sensor:  
contact breaks (output not active)
- Flag enters slot sensor:  
contact makes (output active)

### 2-wire system (standard)

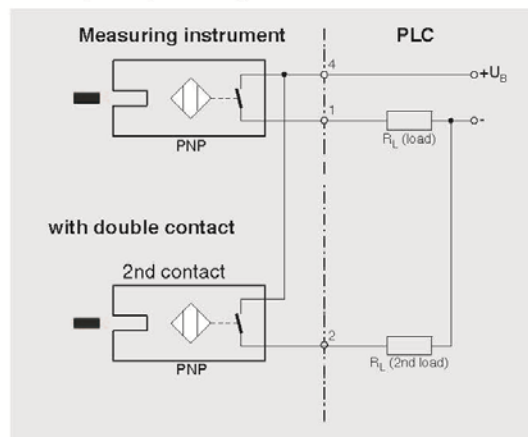

### 3-wire system

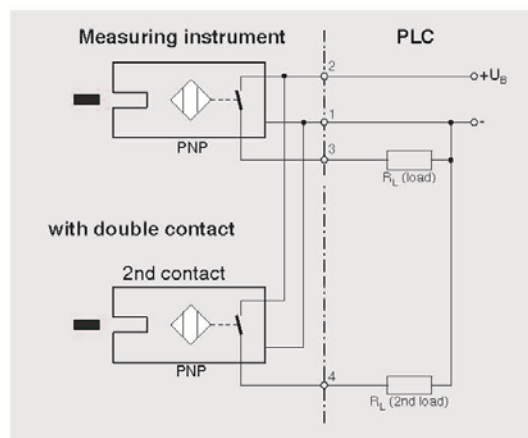

Specifications	Electronic contact model 830 E
Range of operating voltage	DC 10 ... 30 V
Residual ripple	max. 10 %
No-load current	≤ 10 mA
Switching current	≤ 100 mA
Leakage current	≤ 100 µA
Function of switching element	normally open (make contact)
Type of output	PNP transistor
Voltage drop (with I <sub>max.</sub> )	≤ 0.7 V
Protection against pole reversal	conditional UB (the output 3 or 4 switch must never be set directly to minus)
Anti-inductive protection	1 kV, 0.1 ms, 1 kΩ
Oscillator frequency	approx. 1000 kHz
EMC	acc. EN 60947-5-2
Ambient conditions and temperature	depends on measuring instrument
Installation	installed directly in the measuring instrument at the factory, maximum 2 inductive contacts

### Dimensions of control units for inductive contacts

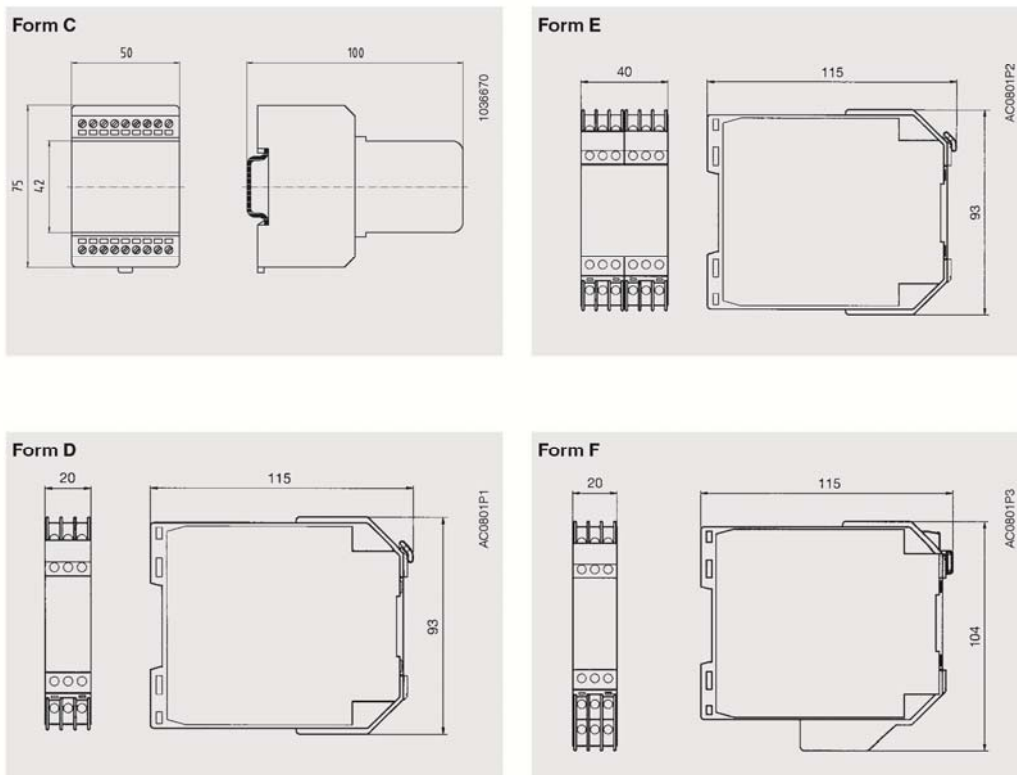

### Control units for inductive contacts

#### Ex-certified versions (Connect. examples see page 23)

##### Control unit model 904.28 KFA6-SR2-Ex1.W

- For instruments having one inductive contact incorporated
- Alarm circuit certified intrinsically safe [EEx ia] IIC to EN 50227 and NAMUR
- 1 SPDT relay contact
- LED indicating circuit status (green), relay output (yellow) and line break (red)
- Surface-mounting case of Form D

##### Note

Direction of action adjustable by sliding switch S1:

OPEN CIRCUIT CAUSES ALARM: switch S1 in position I

CLOSED CIRCUIT CAUSES ALARM: switch S1 in position II

CONTINUITY DETECTION: switch S3 in position I

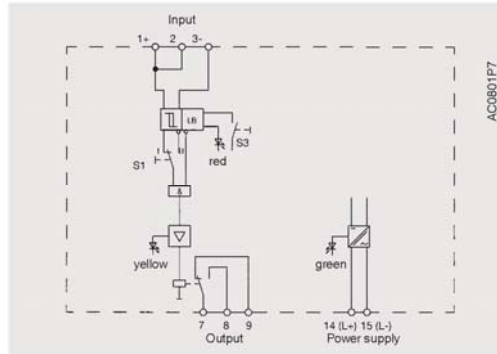

AC0801P7

##### Control unit model 904.29 KFA6-SR2-Ex2.W

- For 1 instrument having two inductive contacts, or two instruments each having one inductive contact incorporated
- Alarm circuit certified intrinsically safe [EEx ia] IIC to EN 50227 and NAMUR
- 2 SPDT relay contacts
- LED indicating circuit status (green), 2 x relay output (yellow) and 2 x line break (red)
- Surface-mounting case of Form F

##### Note

Direction of action adjustable by sliding switches S1 and S2:

OPEN CIRCUIT CAUSES ALARM: switch S1 and S2 in position I

CLOSED CIRCUIT CAUSES ALARM: switch S1 and S2 in pos. II

CONTINUITY DETECTION: switch S3 in position I

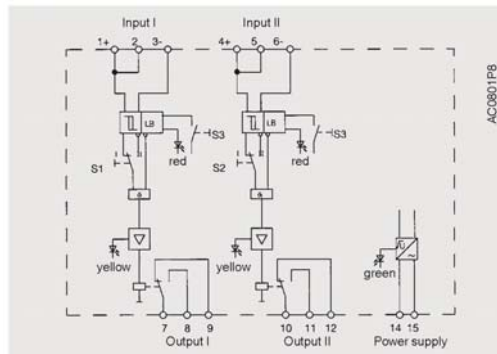

AC0801P8

#### Fail-safe control unit

For important fail-safe switching, type-tested components must be used. The **SN** and **S1N fail-safe inductive contacts** have such approvals (see page 13). When these inductive contacts are used **in conjunction** with **model 904 fail-safe control units**, the arrangement conforms to the TÜV safety-technical requirements for important switching and self-monitoring. When an error arises (mechanical failure, voltage loss, component breakdown, short-circuit, line break) within the circuit, the output always reverts to the fail-safe condition.

##### Model 904.30 KHA6-SH-Ex1

- Fail-safe circuit control unit
- For instruments having one SN- or S1N-type inductive contact built in
- Alarm circuit certified intrinsically safe [EEx ia] IIC
- 1 fail-safe relay output, 1 serially switched output and 1 passive transistor error message output

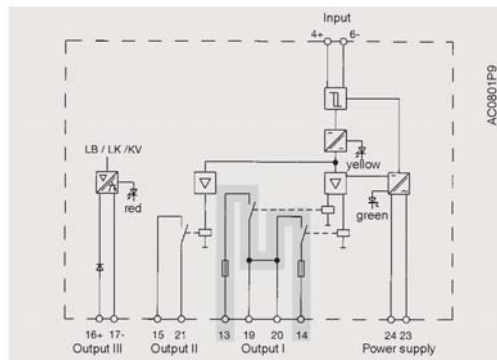

AC0801P9

- LED indicating circuit status (green), relay output (yellow) and line break and short circuit (red)
- Surface-mounting case of Form E



Specifications for control units	Model 904.28 KFA6-SR2- Ex1.W	Model 904.29 KFA6-SR2- Ex2.W	Model 904.30 fail-safe KHA6-SH-Ex1
<b>Power supply</b>			
Line voltage	AC 230 V $\pm$ 0 %, 45 ... 65 Hz	AC 230 V $\pm$ 0 %, 45 ... 65 Hz	AC 85 ... 253 V, 45 ... 65 Hz
Power consumption	1 VA	1.3 VA	3 VA
<b>Input</b>			
No. of contacts	1	2	1
Voltage (reactive)	DC 8 V	DC 8 V	DC 8.4 V
Maximum current	8 mA	8 mA	11.7 mA
Contact actuation	1.2 mA $\leq$ I <sub>s</sub> $\leq$ 2.1 mA	1.2 mA $\leq$ I <sub>s</sub> $\leq$ 2.1 mA	1.2 mA $\leq$ I <sub>s</sub> $\leq$ 5.9 mA
Contact hysteresis	approx. 0.2 mA	approx. 0.2 mA	
Control line impedance	100 Ohm	100 Ohm	50 Ohm
Ex-IS data (as per PTB-certificate)	PTB 00 ATEX 2081	PTB 00 ATEX 2081	PTB 00 ATEX 2043
Voltage	U <sub>0</sub> $\leq$ DC 10.6 V	U <sub>0</sub> $\leq$ DC 10.6 V	U <sub>0</sub> $\leq$ DC 9.6 V
Current	I <sub>0</sub> $\leq$ 19.1 mA	I <sub>0</sub> $\leq$ 19.1 mA	I <sub>0</sub> $\leq$ 19.1 mA
Power rating	P <sub>0</sub> $\leq$ 51 mW	P <sub>0</sub> $\leq$ 51 mW	P <sub>0</sub> $\leq$ 55 mW
IS-classification	[EEx ia] IIC	[EEx ia] IIC	[EEx ia] IIC
Ext. capacitance	2.9 $\mu$ F	2.9 $\mu$ F	650 nF
Ext. inductance	100 mH	100 mH	5 mH
<b>Output</b>			
Relay contacts	1 SPDT	1 ea. SPDT	1 safety directed relay output
Contact rating AC	253 V, 2 A, 500 VA, cos $\phi$ > 0.7	253 V, 2 A, 500 VA, cos $\phi$ > 0.7	250 V, 1 A, cos $\phi$ > 0.7
Contact rating DC	40 V, 2 A; resistive	40 V, 2 A; resistive	24 V, 1 A; resistive
Delay making circuit	approx. 20 ms	approx. 20 ms	20 ms
Delay breaking circuit	approx. 20 ms	approx. 20 ms	20 ms
Max. ON-OFF frequency	10 Hz	10 Hz	5 Hz
<b>Operating conditions</b>			
Min. temperature	-20 °C	-20 °C	-20 °C
Max. temperature	+60 °C	+60 °C	+60 °C
Max. humidity	max. 75%	max. 75%	max. 75%
Ingress protection	IP20 (EN 60529 / IEC 60529)	IP20 (EN 60529 / IEC 60529)	IP20 (EN 60529 / IEC 60529)
<b>Enclosure</b>			
Style	Surface mounting	Surface mounting	Surface mounting
Dimensions per drawing	Form D, page 15	Form F, page 15	Form E, page 15
Mounting	Mounting Snap-fit on 35 mm x 7.5 mm (EN 50022) rail. Direct mounting possible.		
Weight	approx. 0.15 kg	approx. 0.15 kg	approx. 0.28 kg
Order No.	<b>2014505</b>	<b>2014521</b>	<b>2014548</b>

Further control units are available for operation with a supply voltage between DC 20 ... 30 V:

- Model 904.31 (KFD2-SR2- Ex1.W) - 1 relay output  
Order no: 2114003
- Model 904.32 (KFD2-SR2- Ex2.W) - 2 relay outputs  
Order no: 2143569
- Model 904.33 (KFD2-SH- Ex1) - 1 fail-safe relay output (DC 20 ... 35 V)  
Order no: 2307618

**Control units for inductive contacts**

**Non-Ex-certified versions**

(Connection examples see page 23)

**Control unit model 904.25 MSR 010-I**

- For instruments having one inductive contact
- 1 SPDT relay contact
- Surface-mounting case of Form C

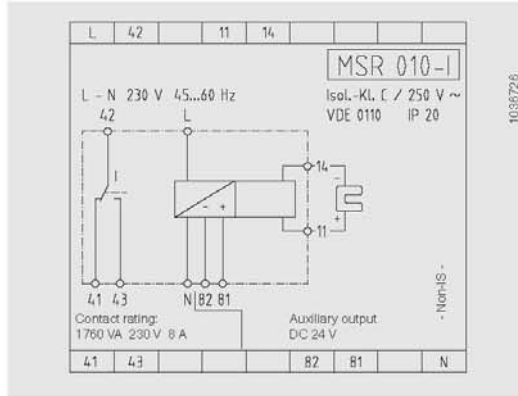

**Control unit model 904.26 MSR 020-I**

- For 1 instrument having two inductive contacts or two instruments each having one inductive contact
- 2 SPDT relay contacts
- Surface-mounting case of Form C

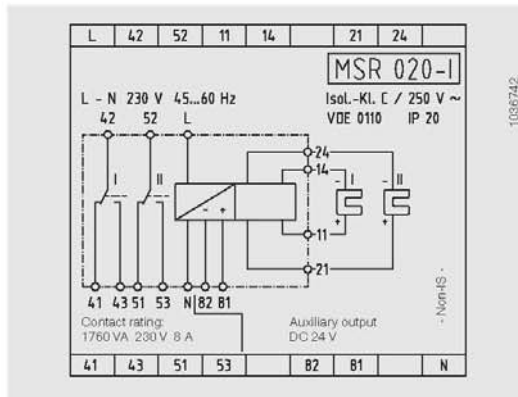

**Control unit model 904.27 MSR 011-I**

- For 2-point (HI-LO) interval switch for control circuits with model 831.12 inductive contacts
- 1 SPDT relay contact
- Surface-mounting case of Form C

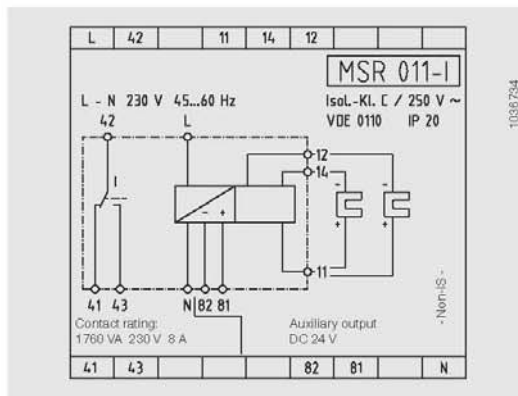

Specifications for control units	Model 904.25 MSR 010-I	Model 904.26 MSR 020-I	Model 904.27 MSR 011-I
<b>Power supply</b>			
Line voltage	AC 230 V -10 % / +6 %, 45 ... 60 Hz		
Power consumption	approx. 2.5 VA		
<b>Input</b>			
No. of contacts	1	2	2
Voltage	DC 8.5 V (typical)		
Maximum current	I <sub>k</sub> approx. 5 mA		
Contact actuation	1.5 mA typical		
Contact hysteresis	approx. 0.2 mA		
<b>Output</b>			
Relay contacts	1 SPDT	1 ea. SPDT	2 SPDT
Contact rating	AC 230 V / 8 A / 1760 VA		
Delay making circuit	approx. 10 ms		
Delay breaking circuit	approx. 10 ms		
Auxiliary output	DC 24 V max. 20 mA		
<b>Operating conditions</b>			
Min. temperature	0 °C		
Max. temperature	+70 °C		
Max. humidity	max. 75 %		
Ingress protection	Case IP40 / terminals IP20 (EN 60529 / IEC 60529)		
<b>Enclosure</b>			
Dimensions per drawing	Form C, page 15		
Material	Polyamide 6.6, green		
Mounting	Snap-fit on 35 x 7.5 mm DIN 50022 rail. Direct mounting feasible.		
<b>Weight</b>	approx. 0.24 kg	approx. 0.27 kg	approx. 0.24 kg

### Options for mounting switch contacts into pressure gauges

Number of contacts, size of instrument (NS) and minimum scale value

Pressure gauge Model	NS	Electrical connections	Magnetic snap-action contacts model 821				Inductive contact model 831 Electronic contact model 830 E <sup>1)</sup>			
			Number of contact sets				Number of contact sets			
			1	2	3	4 <sup>2)</sup>	1	2	3 <sup>3)</sup>	4
			Minimum scale value in bar				Minimum scale value in bar			
212.20	100, 160	A	1	1.6	4	4	1	1.6	1.6	-
232.50	100, 160	A	1	1.6	2.5	2.5	0.6	1	1.6	-
233.50	100, 160	A	1	1.6	2.5	2.5	0.6	1	1.6	-
232.30, 233.30	100	A	1	1.6	4	4	1	1.6	1.6	-
232.30, 233.30	160	B	1	1.6	2.5	2.5	0.6	1	1.6	-
232.36	100	A	1	1.6	4	4	1	1.6	1.6	-
214.11 single system	96 x 96	C	1	1.6	4	-	1	1	-	-
214.11 single system	144 x 144	D	1	1.6	2.5	-	1	1	-	-
214.11 single system	144 x 72	D	1	1.6	-	-	0.6	0.6	0.6	0.6
214.11 double system	144 x 72	D	-	-	-	-	0.6	0.6	-	-
312.20	160	A	1 <sup>5)</sup>	1 <sup>5)</sup>	1.6 <sup>5)</sup>	1.6 <sup>5)</sup>	1	1	1.6	-
332.30	160	B	1 <sup>5)</sup>	1 <sup>5)</sup>	1.6 <sup>5)</sup>	1.6 <sup>5)</sup>	1	1	1.6	-
333.30	160	B	-	-	-	-	1	1	1.6	-
4X2.12	100, 160	A	0.025	0.025	0.025	0.025	0.025	0.025	0.025	-
4X3.12	100, 160	A	0.025	0.025	0.025	0.025	0.025	0.025	0.025	-
422.20 <sup>4)</sup>	100, 160	A	0.025	0.025	0.04	0.04	0.025	0.025	0.025	-
423.20 <sup>4)</sup>	100, 160	A	0.025	0.025	0.04	0.04	0.025	0.025	0.025	-
4X2.30 <sup>4)</sup>	100	A	0.025	0.025	0.04	0.04	0.025	0.025	0.025	-
4X2.30 <sup>4)</sup>	160	B	0.025	0.025	0.04	0.04	0.025	0.025	0.025	-
4X3.30 <sup>4)</sup>	100	A	0.025	0.025	0.04	0.04	0.025	0.025	0.025	-
4X3.30 <sup>4)</sup>	160	B	0.025	0.025	0.04	0.04	0.025	0.025	0.025	-
4X2.50 <sup>4)</sup>	100, 160	A	0.025	0.025	0.04	0.04	0.025	0.025	0.025	-
4X3.50 <sup>4)</sup>	100, 160	A	0.025	0.025	0.04	0.04	0.025	0.025	0.025	-
432.36 <sup>4)</sup>	100	A	0.025	0.025	0.04	0.04	0.025	0.025	0.025	-
432.36 <sup>4)</sup>	160	B	0.025	0.025	0.04	0.04	0.025	0.025	0.025	-
433.36 <sup>4)</sup>	100	A	0.025	0.025	0.04	0.04	0.025	0.025	0.025	-
433.36 <sup>4)</sup>	160	B	0.025	0.025	0.04	0.04	0.025	0.025	0.025	-
432.56 <sup>4)</sup>	100, 160	A	0.025	0.025	0.04	0.04	0.025	0.025	0.025	-
433.56 <sup>4)</sup>	100, 160	A	0.025	0.025	0.04	0.04	0.025	0.025	0.025	-
532.52	100, 160	A	0.04	0.04	0.04	0.04	0.04	0.04	0.04	-
532.53	100, 160	A	0.04	0.04	0.04	0.04	0.04	0.04	0.04	-
532.54	100, 160	A	0.025	0.025	0.04	0.04	0.025	0.025	0.025	-
614.11	96 x 96, 144 x 72	D	-	-	-	-	0.04	0.04	-	-
61X.20	100	A	-	-	-	-	0.1	0.1	-	-
6XX.50	100	A	-	-	-	-	0.1	0.1	-	-
632.51	100, 160	A	0.0025	0.0025	-	-	0.0025	0.0025	0.0025	-
711.11	160	A	1	1.6	4	-	1	1	-	-
711.12	100, 160	A	1	1.6	4	-	1	1	-	-
732.02	100	A	1	1.6	4	-	1	1	-	-
732.14	100, 160	A	0.06	0.06	0.1	0.1	0.06	0.06	0.1	-
733.14	100, 160	A	0.06	0.06	0.1	0.1	0.06	0.06	0.1	-
732.51 <sup>4)</sup>	100, 160	A	0.025	0.025	0.04	0.04	0.025	0.025	0.025	-
736.51	100, 160	A	0.0025 <sup>6)</sup>	0.0025 <sup>6)</sup>	-	-	0.0025	0.0025	0.0025	-

1) Electronic contact model 830 E, only 1 or 2 contacts.

2) It is not possible to set all 4 contacts overlapping.

Either the left (= contact 1) or the right (= contact 4) contact remains at a minimum separation of approx 30° with 100 mm gauges and approx. 15° with 160 mm gauges. However, a special version of 160 mm gauge is available upon request, if the setting of all four contacts to a set value is mandatory.

3) With circular gauges it is not feasible to set all three contacts to a set value in the standard version. Either the no. 1 or the no. 3 contact remains at a minimum separation of 30° from the other two. However, a special version of 160 mm gauge is available upon request. See also page 13.

4) Pressure range 0 ... 0.025 bar; class 2.5.

5) Without magnet.

6) After feasibility test when intended for flammable gases.

## Incorporating switch contacts into thermometers

### Number of contacts and size of instrument (NS)

Thermometer		Elec- trical connec- tions	Magnetic snap-action contacts model 821			Sliding contacts <sup>1)</sup> model 811			Inductive contact model 831 Electronic contact model 830 E <sup>2)</sup>		
Model	NS		Number of contact sets			Number of contact sets			Number of contact sets		
			1	2	3	1	2	3	1	2	3
55	100	A	on request			x	x	-	x	x	-
55	160	B	on request			x	x	-	x	x	-
73	100	E	x	x	x	x	x	x	x	x	
73	160	E	x	x	x	x	x	x	x	x	
73	144 x 144	D	x	x	on request	x	x	on request	x	x	on request

1) Not for liquid-damped gauges

2) Electronic contact model 830 E, only 1 or 2 contacts

### Standard electrical connections

The letter indicates the standard wiring method of pressure gauges and thermometers incorporating 1 or 2 contacts. "Left" or "right" refers to an observer facing the dial of the instrument.

A Junction box made of PA 6, black, ingress protection IP65  
Temperature resistance -40 ... +80 °C, per VDE 0110  
Insulation group C/250 V  
Cable gland M20 x 1.5 (bottom entry) with retainer clamp, 6 + screw terminals + PE for wire cross section 2.5 mm<sup>2</sup> mounted at the right-hand side of the case

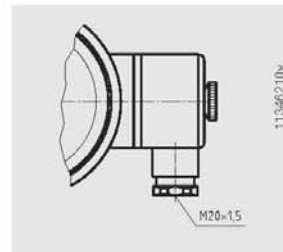

B Junction box made of PA 6, black, ingress protection IP65  
Temperature resistance -40 ... +80 °C, per VDE 0110  
Insulation group C/250 V  
Cable gland M20 x 1.5 (bottom entry) with retainer clamp, 4 screw terminals + PE for wire cross section 2.5 mm<sup>2</sup> mounted at the right-hand side of the case

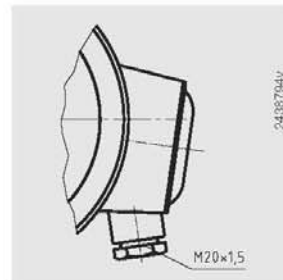

C Block of terminals, for wire cross section 2.5 mm<sup>2</sup>, mounted at the back of the case

D Block of rack-mounting terminals DIN 41611 per VDE 0110  
Insulation group C, for wire cross section 2.5 mm<sup>2</sup>, mounted at the back of the case or chassis

E Junction box as A, but mounted at the left-hand side of the case

For instruments incorporating 3 or more contacts and special versions of contacts: wiring on request.

**Option:** Plug connection (e.g. DIN 43650) on request

### Dimensions in mm (Examples)

#### Gauge with contacts NS 100

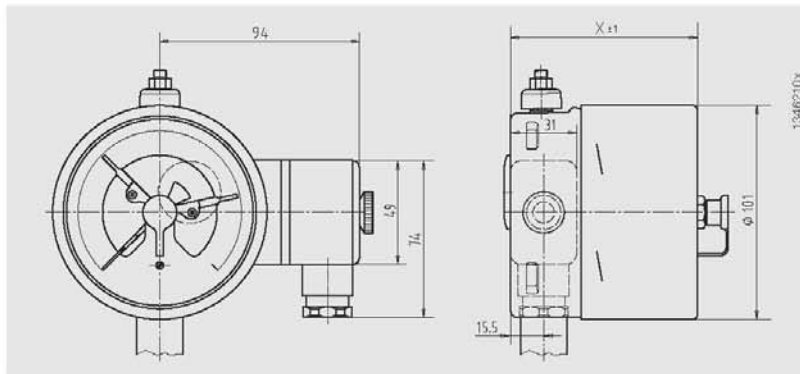

Kind of contact	Dimension X in mm
Single or double contacts	88
Double contact (change-over)	113
Triple contact	96
Quadruple contact	113

#### Gauge with contacts NS 160

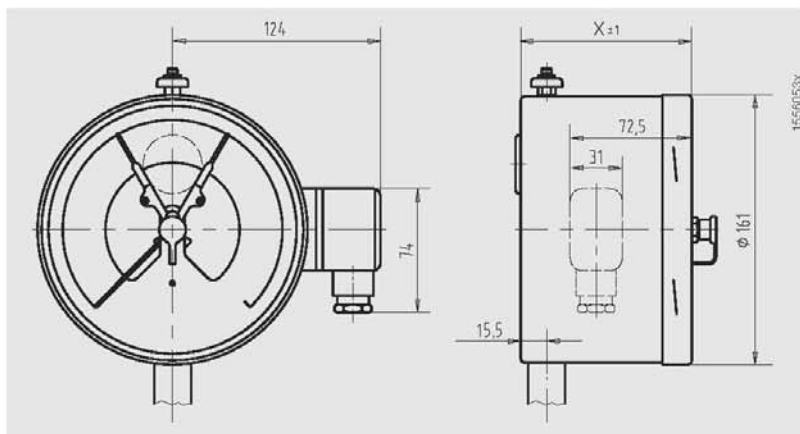

Kind of contact	Scale range	Dimension X
Single or	up to 0 ... 60 bar <sup>1)</sup>	102 mm
Double contact	≥ 0 ... 100 bar	116 mm
Triple or	up to 0 ... 60 bar <sup>1)</sup>	116 mm
Quadruple contact	≥ 0 ... 100 bar	129.5 mm

1) also for mechanical thermometers

**Connection examples for inductive contacts**

Ex version, with model 904.28/29/30, K\*A6-SR2(SH)-Ex control units

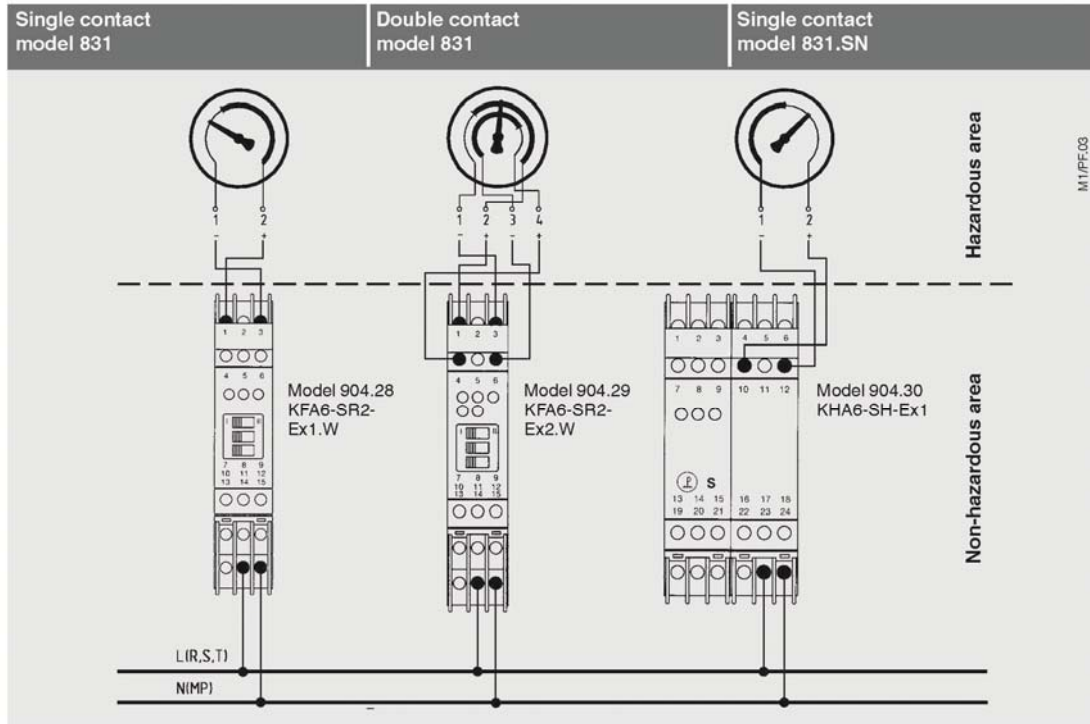

Non-Ex version, with model 904.2X control units

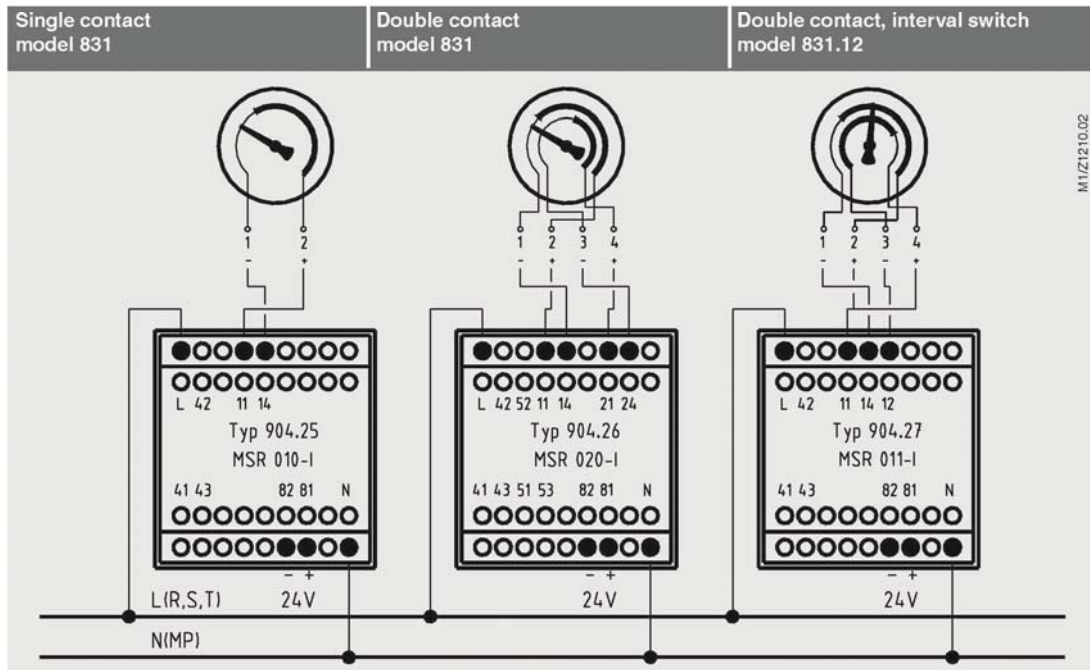

© 2009 WIKA Alexander Wiegand SE & Co. KG, all rights reserved.  
The specifications given in this document represent the state of engineering at the time of publishing.  
We reserve the right to make modifications to the specifications and materials.



**WIKAL**  
**WIKAL Alexander Wiegand SE & Co. KG**  
Alexander-Wiegand-Straße 30  
63911 Klingenberg/Germany  
Tel. +49 9372 132-0  
Fax +49 9372 132-406  
info@wika.de  
www.wika.de

02/2017 EN