

»multifix« series

Pneumatic systems or parts of systems can be switched on and off by means of an electrical signal. When they are switched off, the system is relieved at the same time.

Duty cycle:	100 %
Protection IP:	IP65 (P 54) acc. to DIN 40050
Electrical connection:	Device plug PG 9, type B, EN 175301-803
Max. medium temperature:	60 °C
Max. ambient temperature:	60 °C
Sealant:	NBR
Flow rate measurement:	At P ₁ = 6 bar and pressure drop Δp = 1 bar

On-off valve (3/2-way valve)

Art. No.	Type No.	Thread	Solenoid	Control range bar	Flow rate l/min	Housing	Vent port	Size
133137	S 44-3	G 3/4	110 V AC, 50 Hz	2 - 16	12500	Die-cast aluminium	Silencer G 1/2	4

Accessories / spare parts

Art. No.	Type No.	Description
135858	ZW 45	Mounting bracket with 2 screws
135857	KP 45	Coupler pack for modular assembly of several devices
154029	400-900-115	Pilot valve 115 V AC
100308	400-900-17	Pilot valve 230 V AC
100309	400-900-301	Pilot valve 24 V AC
100306	400-900-42	Pilot valve 24 V DC
100310	1920.FU	Connector type C

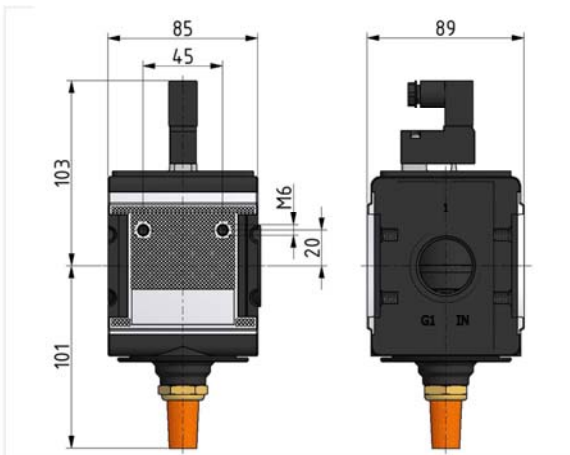

flow characteristic

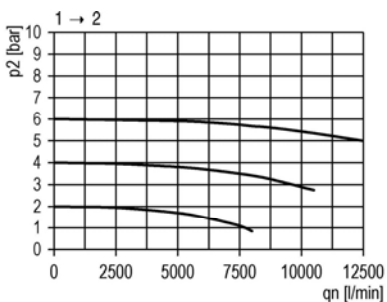

rear exhaust

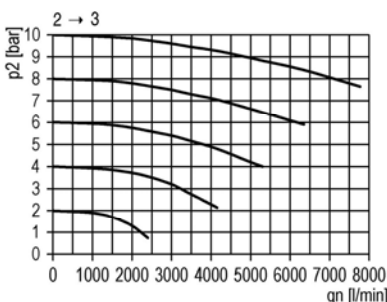

symbol

