

Double-Acting Standard Cylinder According to ISO 15552 with Magnetic Piston

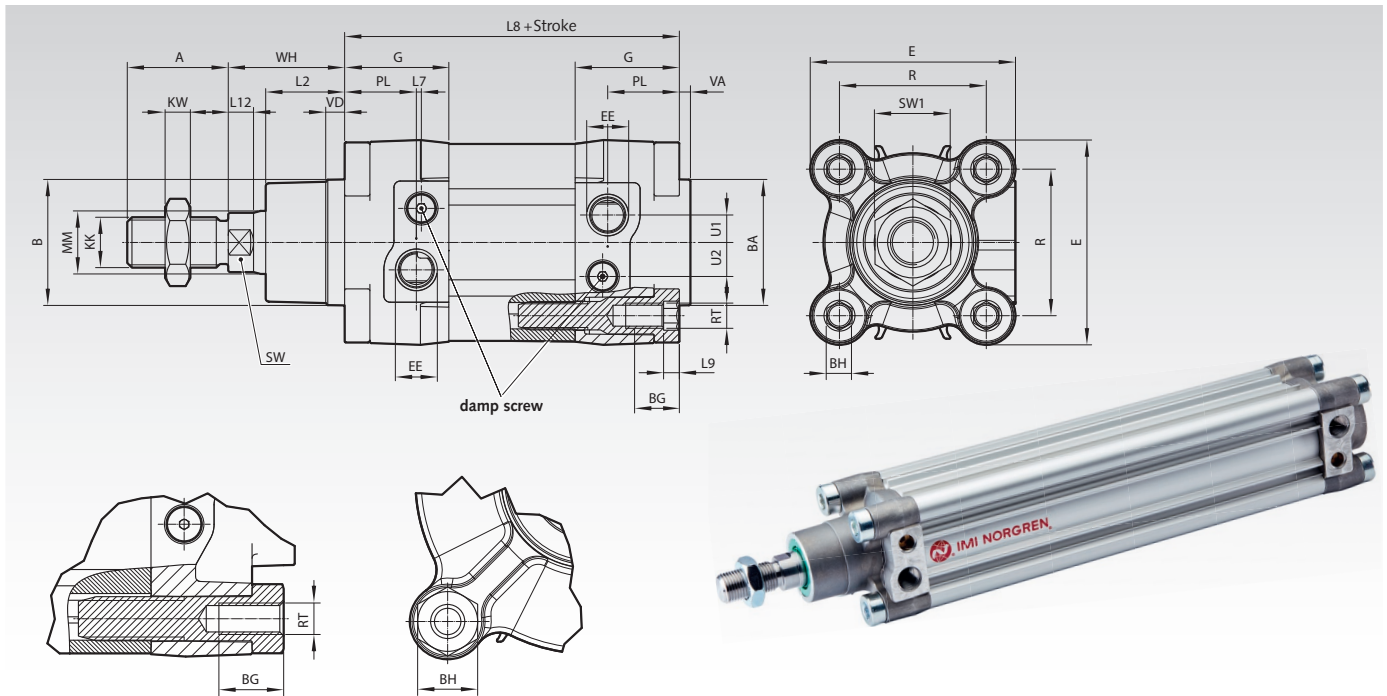

Materials: Profile barrel: Anodised aluminium. End covers: Aluminium die-cast. Piston rod: Stainless steel (ferritic), Piston and piston rod seals: PUR. O-ring seals: NBR.

Medium: Compressed air, filtered, lubricated or non-lubricated.
Standard: ISO 15552.

Mode of operation: Double-acting with magnetic piston and adjustable, adaptive end-of-stroke cushioning system ACS.

Operating pressure: 1 to 12 bar.

Operating temperature: -20°C to +80°C.

Below +2°C please consider the air quality.

Cylinder Ø mm	Theoretical Forces (N) at 6 bar		Cushion Length mm	Initial Cushion Volume cm ³
	Thrust	Pull		
32	482	414	20	12,8
40	754	633	22	20,2
50	1178	990	24	36
63	1870	1680	24	64
80	3016	2722	26	111

Ordering details: e.g.: Product No. 801 320 25, Double-Acting Standard Cylinder According to ISO 15552 with Magnetic Piston, Cylinder Ø 32 mm, Stroke 25 mm

Symbol	Product No.	Standard Strokes							Cylinder- Ø mm	Connection
		25 mm	50 mm	80 mm	100 mm	125 mm	160 mm	200 mm		
	801 320 25	801 320 50	801 320 80	801 321 00	801 321 25	801 321 60	801 322 00	801 322 50	32	G ¹ / ₈
	801 400 25	801 400 50	801 400 80	801 401 00	801 401 25	801 401 60	801 402 00	801 402 50	40	G ¹ / ₄
	801 500 25	801 500 50	801 500 80	801 501 00	801 501 25	801 501 60	801 502 00	801 502 50	50	G ¹ / ₄
	801 630 25	801 630 50	801 630 80	801 631 00	801 631 25	801 631 60	801 632 00	801 632 50	63	G ³ / ₈
	801 800 25	801 800 50	801 800 80	801 801 00	801 801 25	801 801 60	801 802 00	801 802 50	80	G ³ / ₈

Cyl. Ø mm	A mm	Ø B ^{d11} mm	Ø BA ^{d11} mm	BG mm	BH mm	E mm	EE mm	G mm	KK mm	KW mm	L ₂ mm	L ₇ mm	L ₈ mm	L ₉ mm	L ₁₂ mm
32	22	30	30	16	6	47	G ¹ / ₈	29	M10x1,25	5	19,5	6,6	94	4	5,5
40	24	35	35	16	6	53	G ¹ / ₄	34,5	M12x1,25	6	22	5,6	105	4	6,5
50	32	40	40	16	8	65	G ¹ / ₄	33	M16x1,5	8	25	1,6	106	5	8
63	32	45	45	16	8	75	G ³ / ₈	36,5	M16x1,5	8	25	3,6	121	5	8
80	40	45	45	17	19	95	G ³ / ₈	42	M20x1,5	10	33	1,8	128	-	10

Cyl. Ø mm	MM ^{h9} mm	PL mm	R mm	RT mm	SW mm	SW1 mm	U ₁ mm	U ₂ mm	VA mm	VD mm	WH mm	Weight in kg at 0 mm per 25 mm	
32	12	15,0	32,5	M6	10	17	4,6	6,3	3,5	6	26	0,49	0,06
40	16	21,5	38	M6	13	19	5,8	9,2	3,5	6	30	0,69	0,08
50	20	22,7	46,5	M8	17	24	8,7	10,8	3,5	6	37	1,09	0,12
63	20	24,2	56,5	M8	17	24	10,0	12,8	3,5	6	37	1,54	0,13
80	25	29,7	72	M10	22	30	12,0	14,5	3,5	6	46	2,64	0,20

Mounting Elements for Standard Cylinders

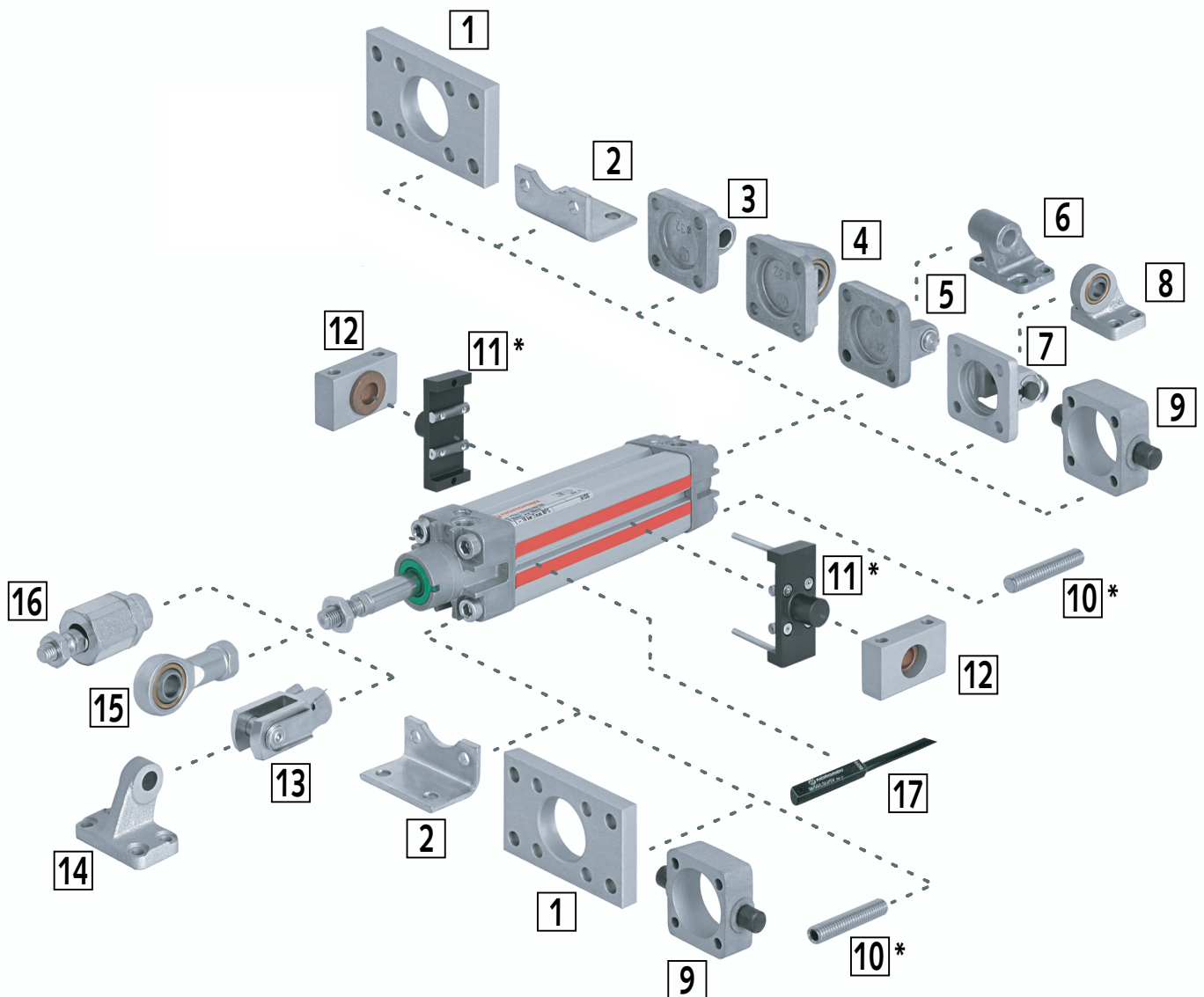

No. Designation	Cylinder Ø 32mm Product No.	Cylinder Ø 40mm Product No.	Cylinder Ø 50mm Product No.	Cylinder Ø 63mm Product No.	Cylinder Ø 80mm Product No.	Dim. Page*
1 Rear Flange, Front Flange	810 001 32	810 001 40	810 001 50	810 001 63	810 001 80	816
2 Foot Plate Mounting	810 002 32	810 002 40	810 002 50	810 002 63	810 002 80	816
3 Rear Eye Mounting	810 004 32	810 004 40	810 004 50	810 004 63	810 004 80	816
4 Rear Eye Mounting with Spherical Bearing	810 012 32	810 012 40	810 012 50	810 012 63	810 012 80	817
5 Rear Clevis Mounting Slim	810 007 32	810 007 40	810 007 50	810 007 63	810 007 80	817
6 Bracket Hinge Mounting, Rigid, Wide for No. 5	810 010 32	810 010 40	810 010 50	810 010 63	810 010 80	817
7 Rear Clevis Mounting Slim	810 008 32	810 008 40	810 008 50	810 008 63	810 008 80	818
8 Bracket Hinge Mounting with Spherical Bearing No. 7	810 011 32	810 011 40	810 011 50	810 011 63	810 011 80	818
9 Trunnion Mounting	810 013 32	810 013 40	810 013 50	810 013 63	810 013 80	818
10 Front or Rear Stud Mounting *	810 006 32*	810 006 32*	810 006 50*	810 006 50*	810 006 80*	-
11 Adjustable Trunnion Mounting *	810 014 32*	810 014 40*	810 014 50*	810 014 63*	810 014 80*	-
12 Swivel Bearing Sets for No.9 oder No.11	810 015 32	810 015 40	810 015 40	810 015 63	810 015 63	819
13 Clevis	810 003 25	810 003 40	810 003 50	810 003 50	810 003 80	819
14 Bracket Hinge Mounting, Rigid, Slim, for No.13	810 009 32	810 009 40	810 009 50	810 009 63	810 009 80	819
15 Rod End	810 005 25	810 005 40	810 005 50	810 005 50	810 005 80	820
16 Piston Rod Swivel Mounting	810 000 25	810 000 40	810 000 50	810 000 50	810 000 80	820

* Discontinued item.

No. 17: Magnetic switches 810 000 01 to 810 000 07 (page 823) can be mounted straight on the keyways of the profile barrel, without further elements.